

DETAIL A
SCALE 1 : 1



MEDAccess Inc.

Phone & Text **828-264-4085**

E-mail: medaccess@medaccessinc.com

Website: www.medaccessinc.com

RAMP
MODEL:

MRED 200

RAMP
HEIGHT:

1.27 CM

LAST
UPDATE:

9/3/20

UNLESS OTHERWISE SPECIFIED:
DIMENSIONS ARE IN **CENTIMETERS**

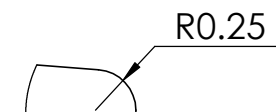
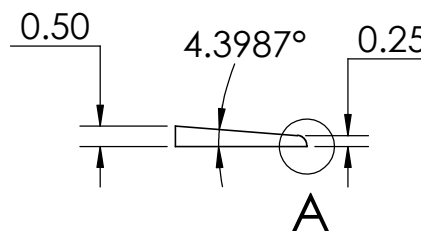
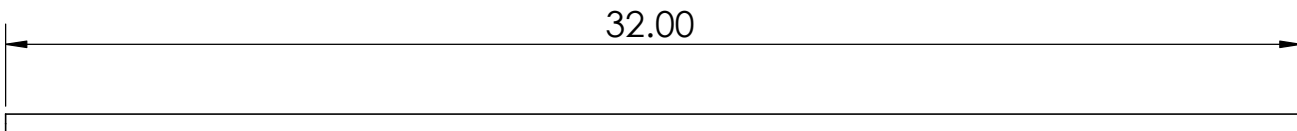
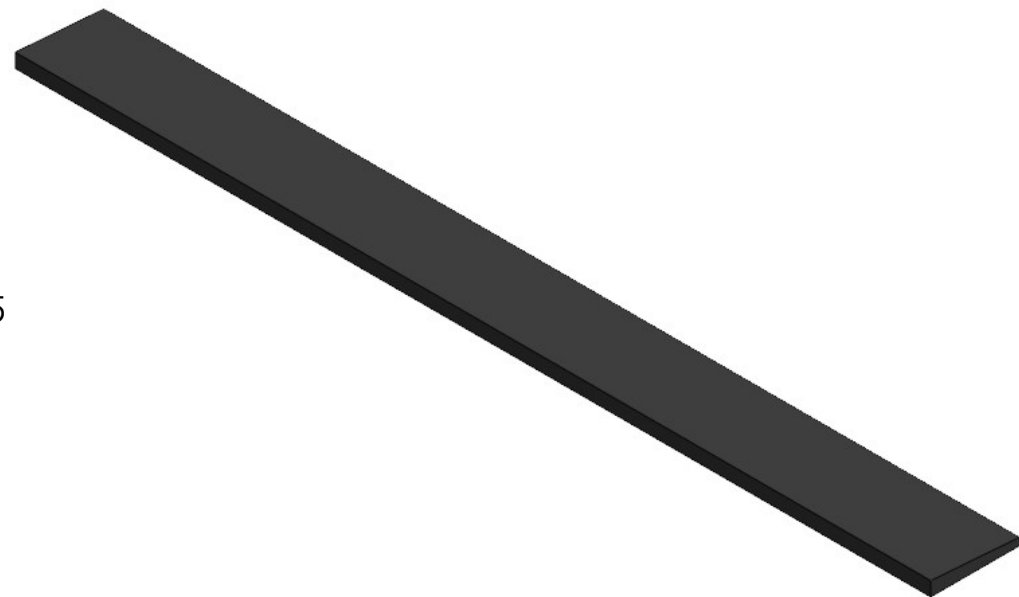

DETAIL A
SCALE 1 : 1



MEDAccess Inc.

Phone & Text **828-264-4085**

E-mail: medaccess@medaccessinc.com

Website: www.medaccessinc.com

RAMP
MODEL:

MRED 200

RAMP
HEIGHT:

1/2 INCH

LAST
UPDATE: 8/17/20

UNLESS OTHERWISE SPECIFIED:
DIMENSIONS ARE IN **INCHES**

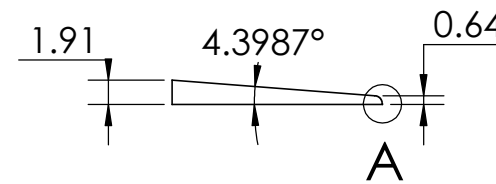
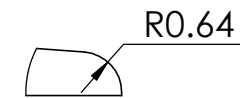
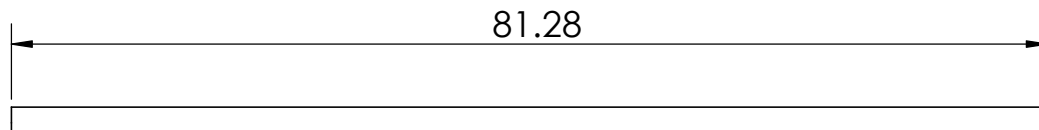
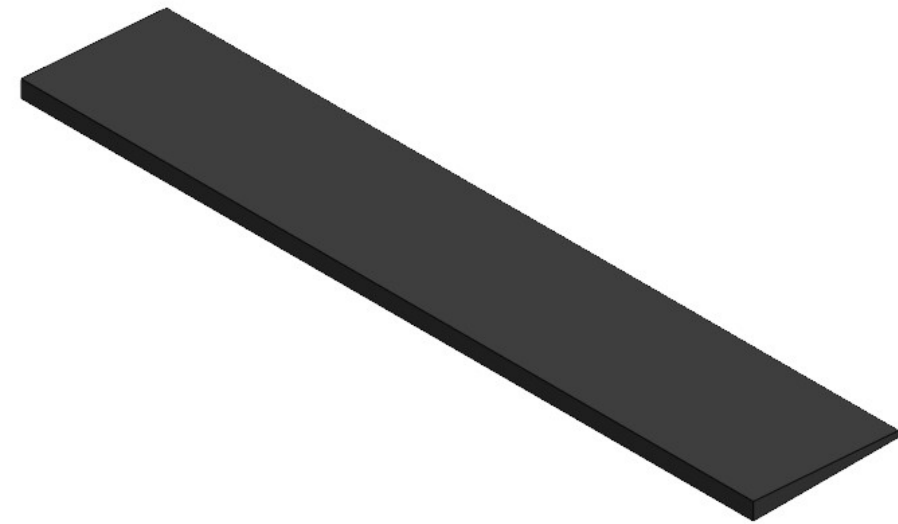
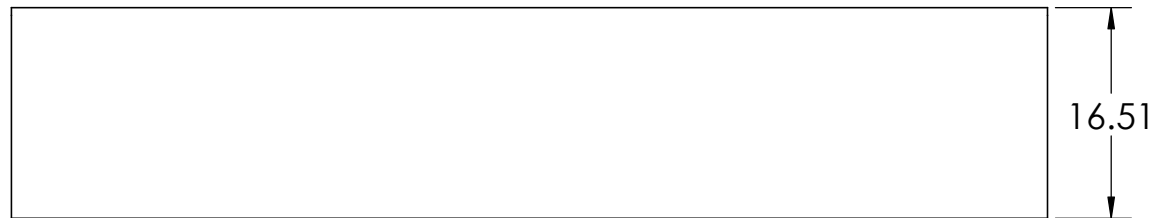

DETAIL A
SCALE 1 : 1



MEDAccess Inc.
Phone & Text **828-264-4085**
E-mail: medaccess@medaccessinc.com
Website: www.medaccessinc.com

RAMP MODEL:	MRED 300
RAMP HEIGHT:	1.905 CM
LAST UPDATE:	9/3/20
UNLESS OTHERWISE SPECIFIED: DIMENSIONS ARE IN CENTIMETERS	

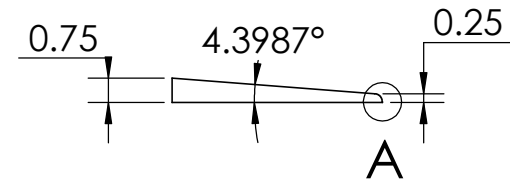
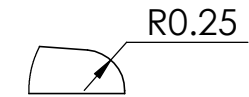
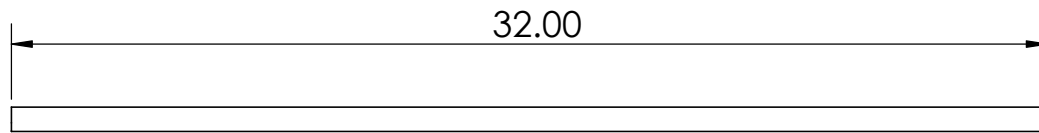
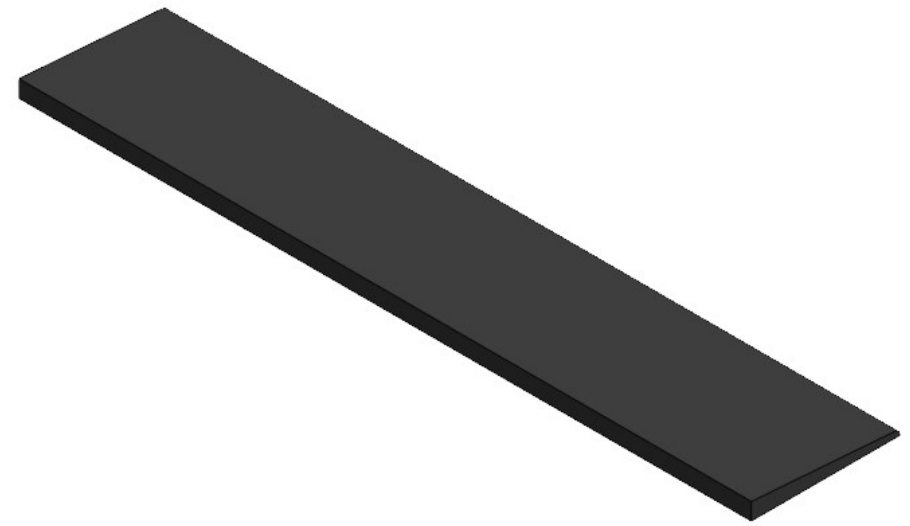
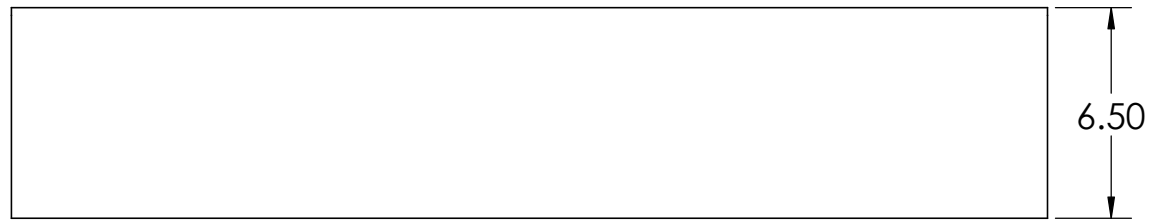

DETAIL A
SCALE 1 : 1



MEDAccess Inc.
Phone & Text **828-264-4085**
E-mail: medaccess@medaccessinc.com
Website: www.medaccessinc.com

RAMP MODEL:	MRED 300
RAMP HEIGHT:	1/2 INCH
LAST UPDATE:	8/17/20
UNLESS OTHERWISE SPECIFIED: DIMENSIONS ARE IN INCHES	

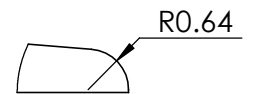
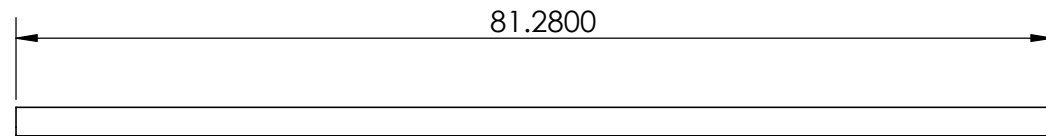
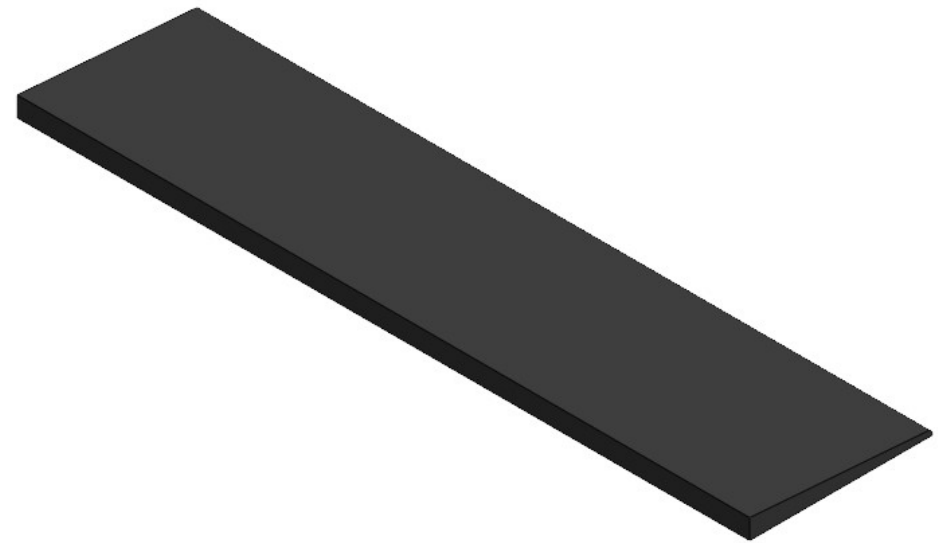
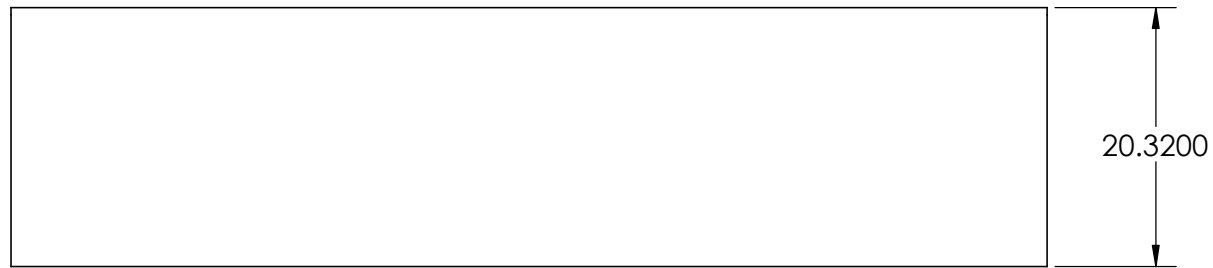

DETAIL A
SCALE 1 : 1

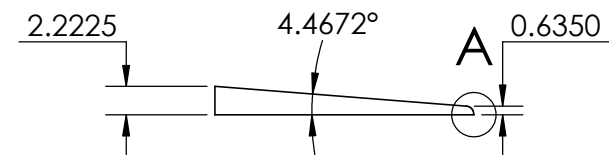

MEDAccess Inc.

Phone & Text **828-264-4085**

E-mail: medaccess@medaccessinc.com

Website: www.medaccessinc.com

RAMP
MODEL:

MRED 400

RAMP
HEIGHT:

2.22 CM

LAST
UPDATE:

8/17/20

UNLESS OTHERWISE SPECIFIED:
DIMENSIONS ARE IN **CENTIMETERS**

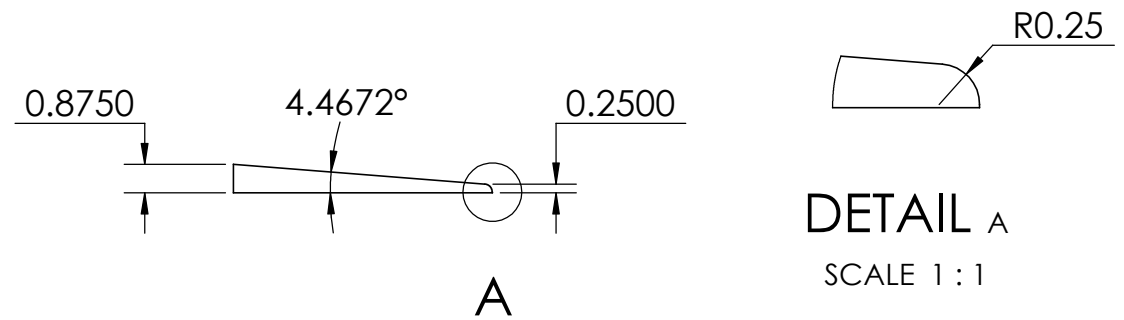
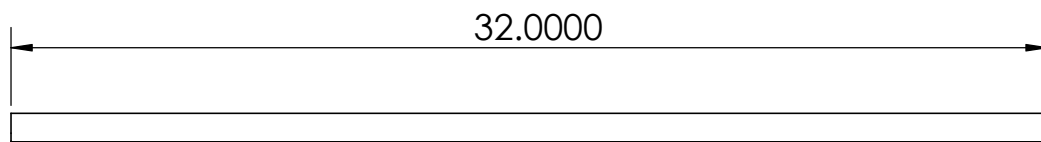
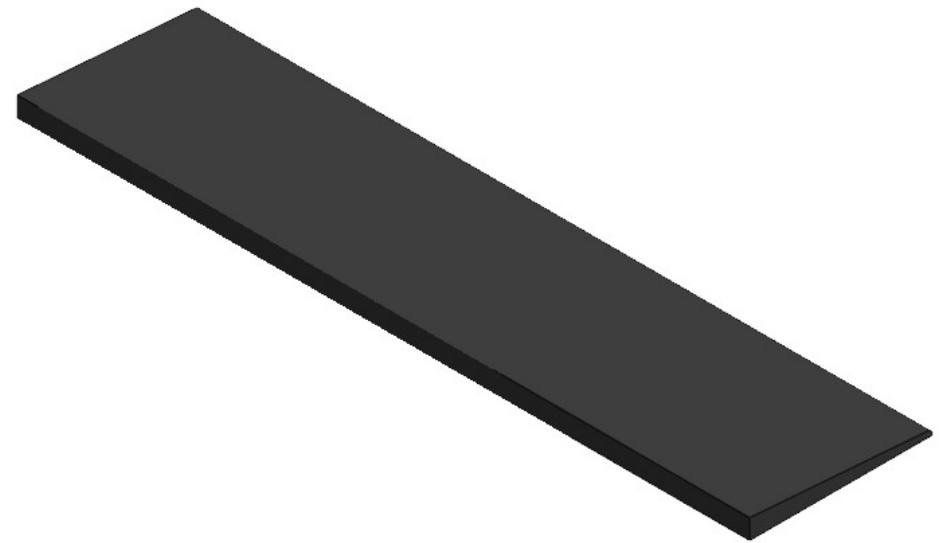
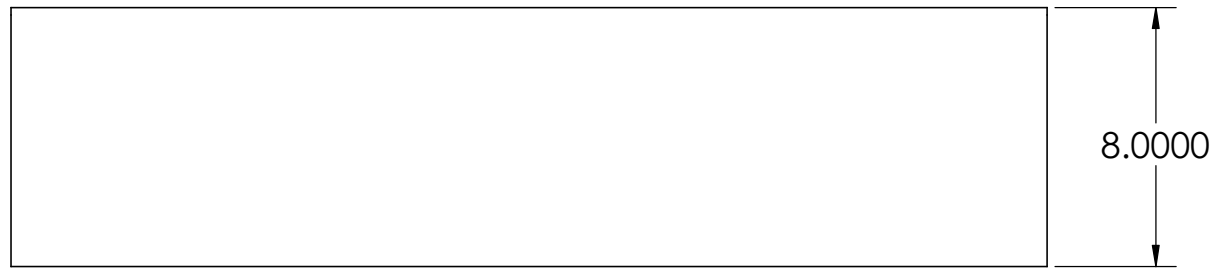

DETAIL A
SCALE 1 : 1



MEDAccess Inc.

Phone & Text **828-264-4085**

E-mail: medaccess@medaccessinc.com

Website: www.medaccessinc.com

RAMP
MODEL:

MRED 400

RAMP
HEIGHT:

0.875 INCHES

LAST
UPDATE:

8/17/20

UNLESS OTHERWISE SPECIFIED:
DIMENSIONS ARE IN **INCHES**

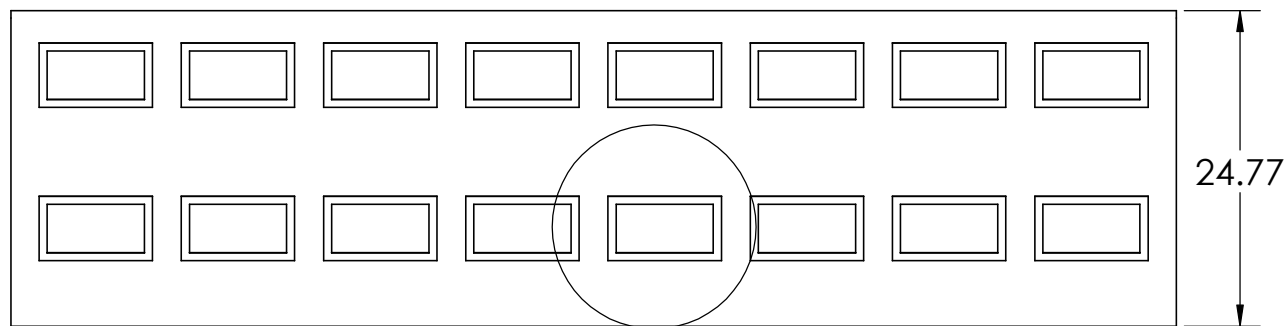

B

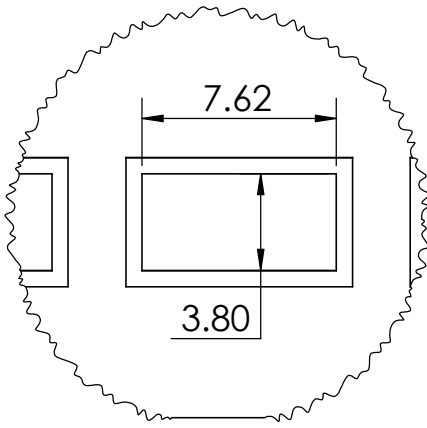
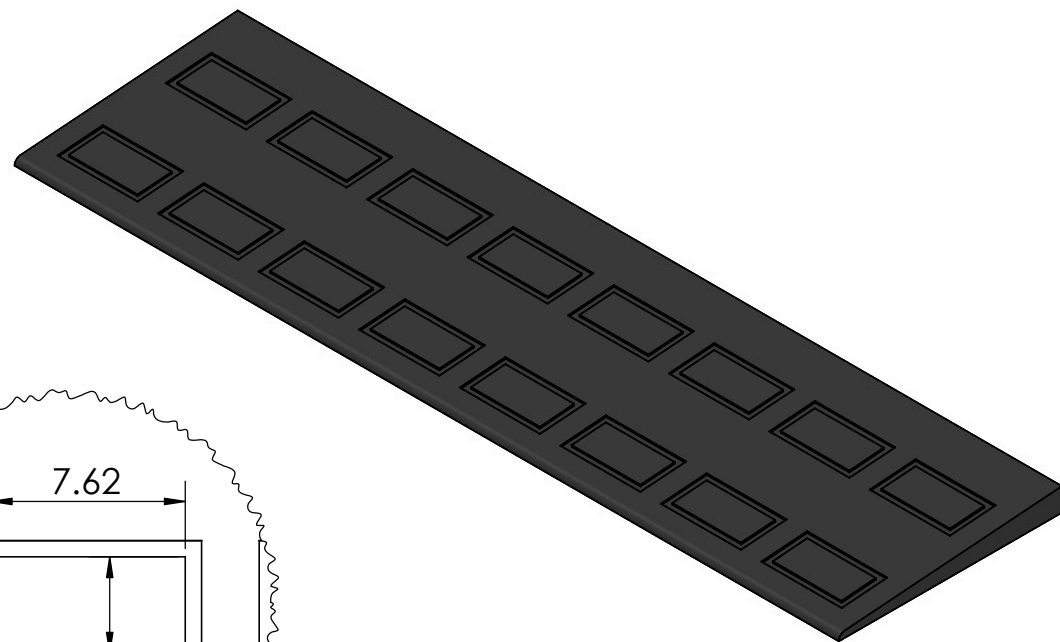
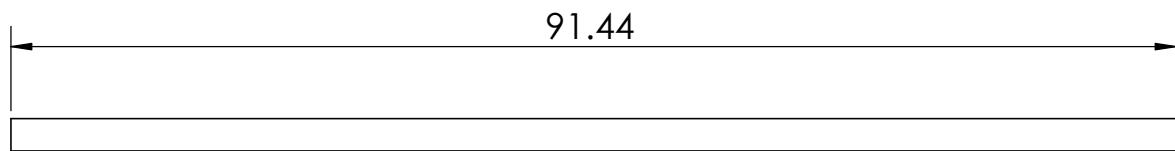

DETAIL B

SCALE 2 : 5

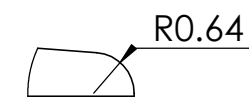
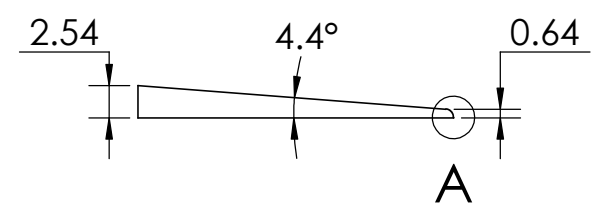

DETAIL A

SCALE 1 : 1



MEDAccess Inc.

Phone & Text **828-264-4085**

E-mail: medaccess@medaccessinc.com

Website: www.medaccessinc.com

RAMP MODEL:	MRED 500
RAMP HEIGHT:	2.54 CM
LAST UPDATE:	8/17/20
UNLESS OTHERWISE SPECIFIED: DIMENSIONS ARE IN CENTIMETERS	

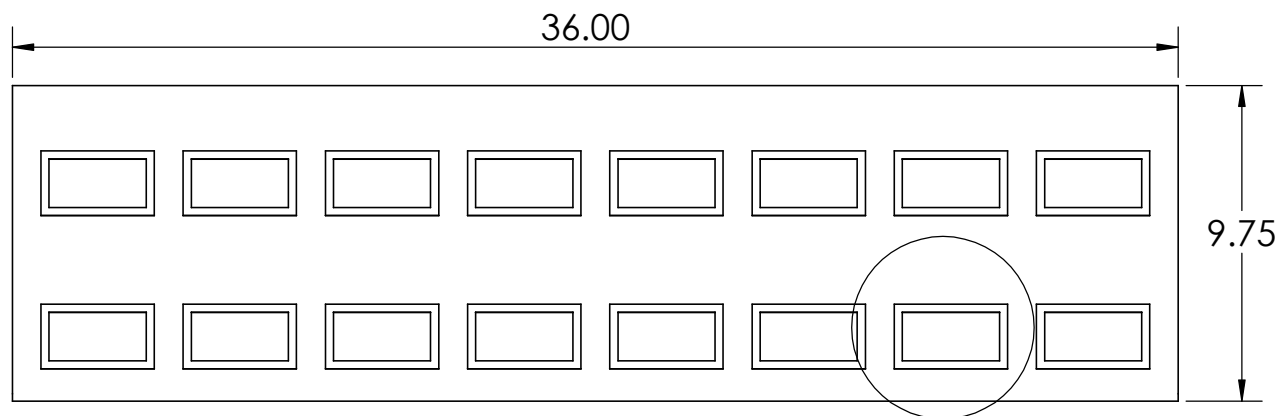

B

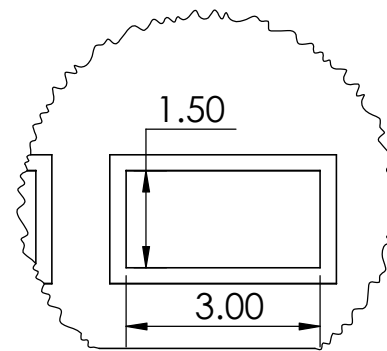
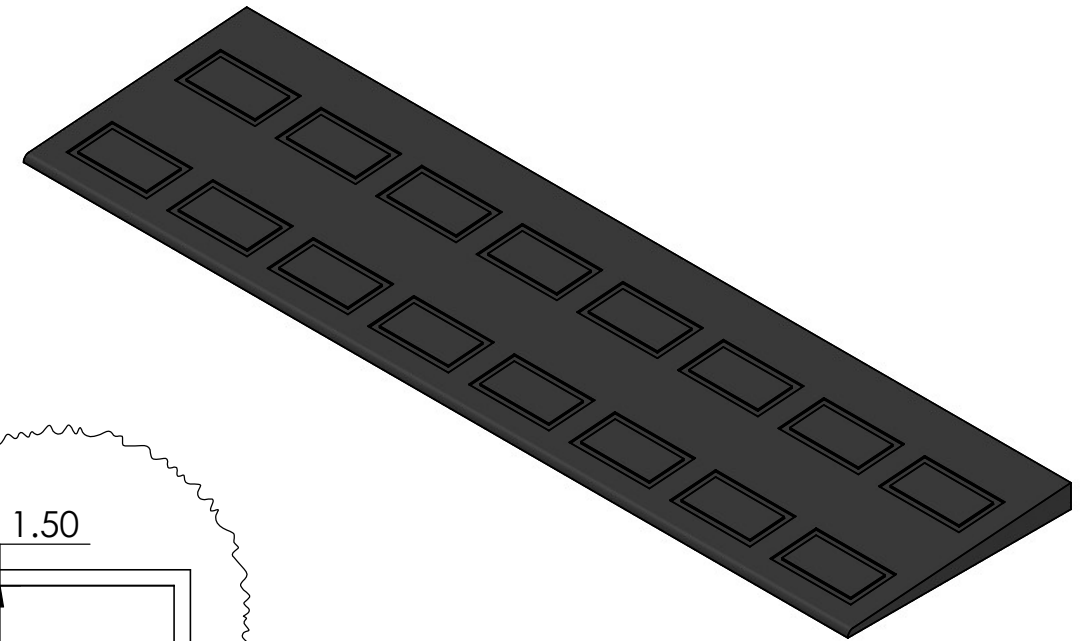

DETAIL B

SCALE 2 : 5

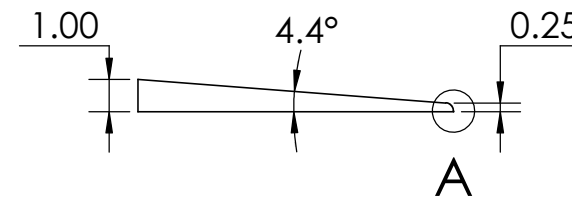
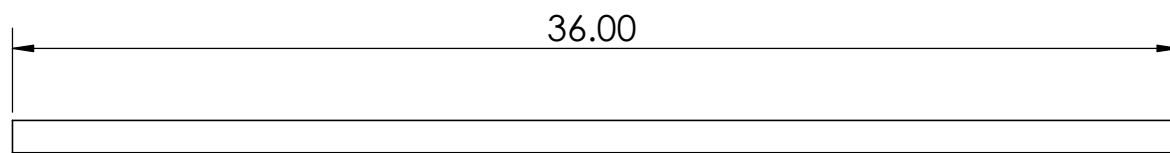

A

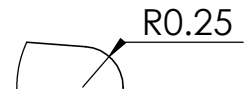

DETAIL A

SCALE 1 : 1



MEDAccess Inc.

Phone & Text **828-264-4085**

E-mail: medaccess@medaccessinc.com

Website: www.medaccessinc.com

RAMP
MODEL:

MRED 500

RAMP
HEIGHT:

1 INCH

LAST
UPDATE:

8/17/20

UNLESS OTHERWISE SPECIFIED:
DIMENSIONS ARE IN **INCHES**

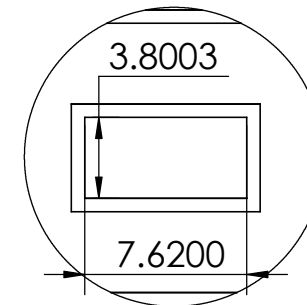
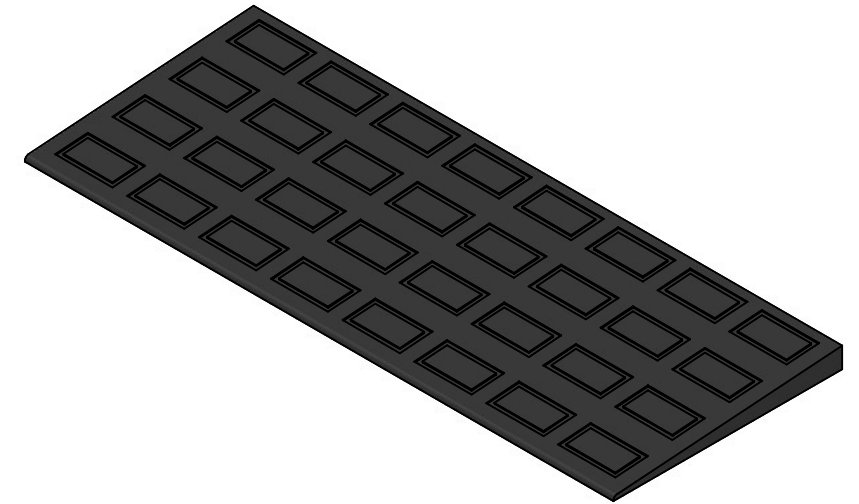
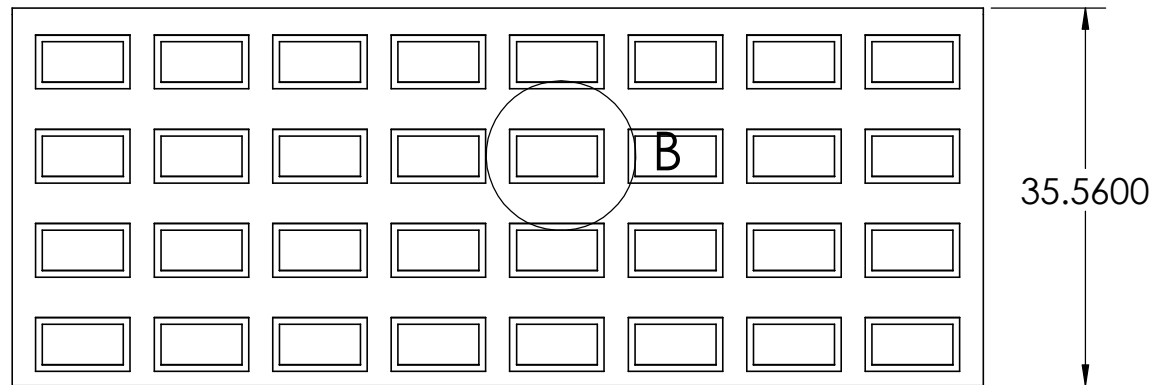

DETAIL B
SCALE 1 : 3

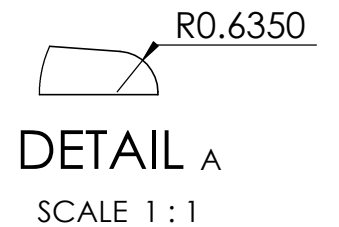
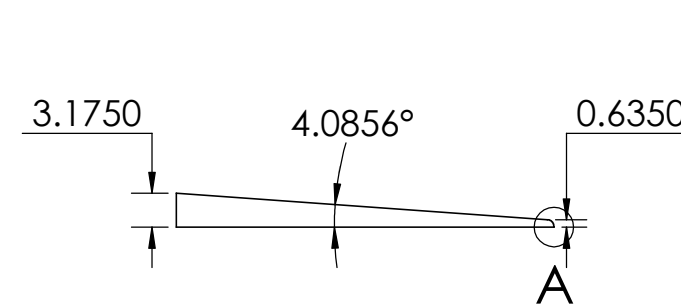
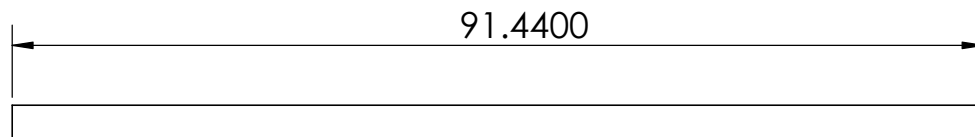

DETAIL A
SCALE 1 : 1



MEDAccess Inc.

Phone & Text **828-264-4085**

E-mail: medaccess@medaccessinc.com

Website: www.medaccessinc.com

RAMP
MODEL:

MRED 500

RAMP
HEIGHT:

3.1750 CM

LAST
UPDATE:

8/17/20

UNLESS OTHERWISE SPECIFIED:
DIMENSIONS ARE IN **CENTIMETERS**

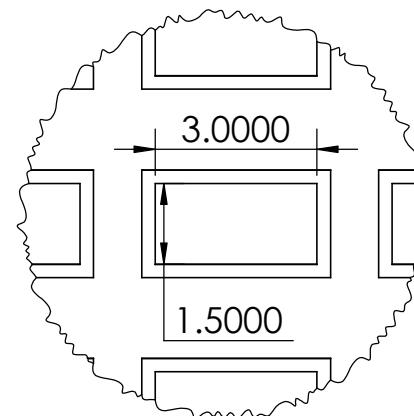
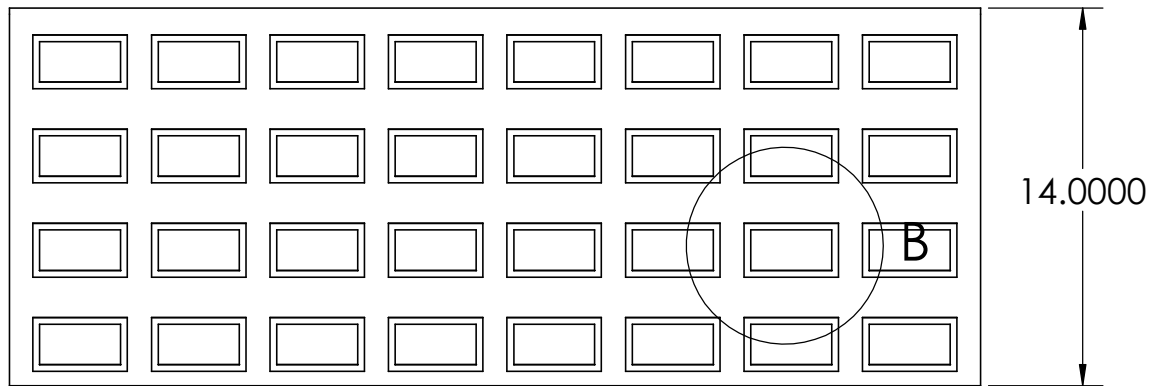

DETAIL B

SCALE 1 : 3

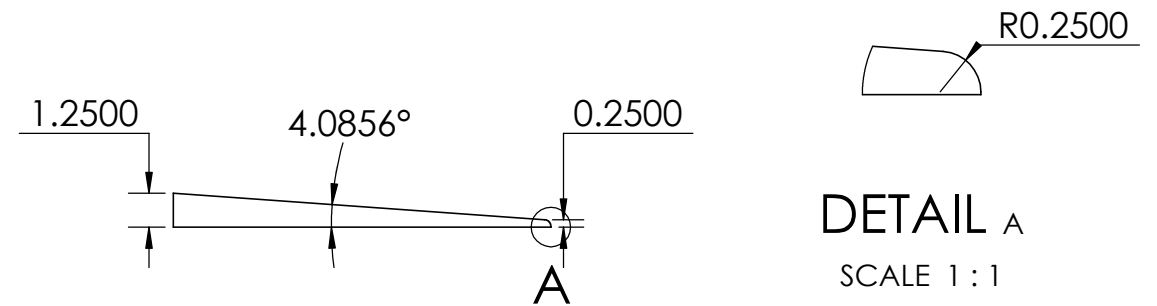
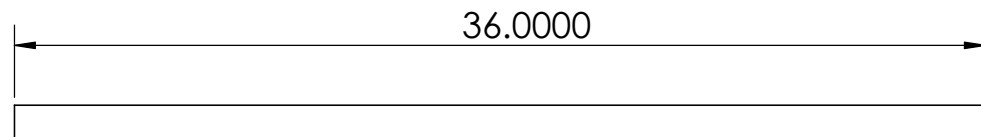
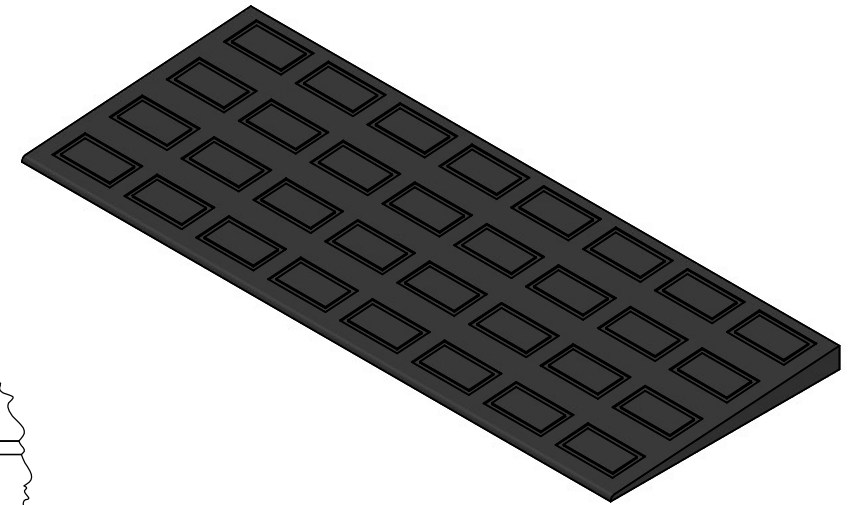

DETAIL A

SCALE 1 : 1



MEDAccess Inc.

Phone & Text **828-264-4085**

E-mail: medaccess@medaccessinc.com

Website: www.medaccessinc.com

RAMP
MODEL:

REDUCER 600

RAMP
HEIGHT:

1.25 INCHES

LAST
UPDATE:

8/17/20

UNLESS OTHERWISE SPECIFIED:
DIMENSIONS ARE IN **INCHES**

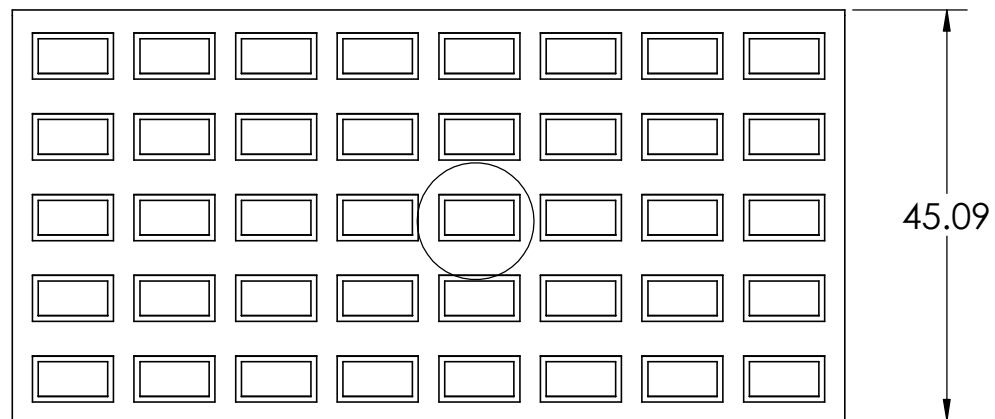

B

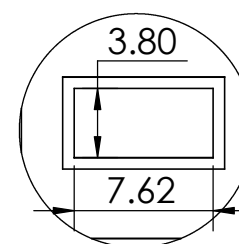
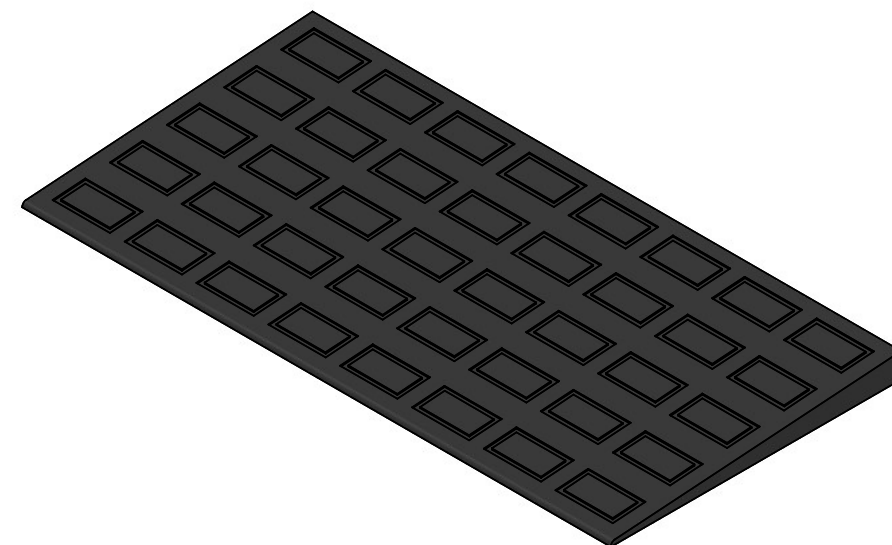

DETAIL B

SCALE 2 : 7

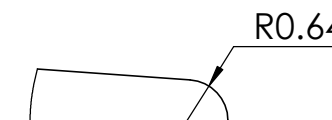
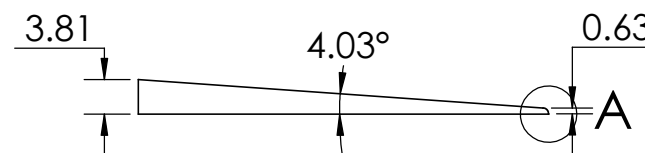
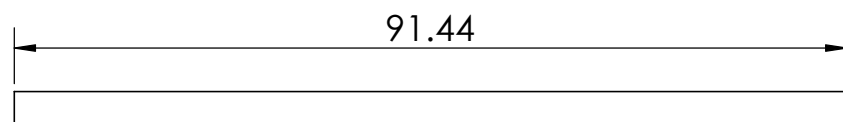

DETAIL A

SCALE 1 : 1



MEDAccess Inc.

Phone & Text **828-264-4085**

E-mail: medaccess@medaccessinc.com

Website: www.medaccessinc.com

RAMP
MODEL:

MRED 700

RAMP
HEIGHT:

3.81 CM

LAST
UPDATE:

8/17/20

UNLESS OTHERWISE SPECIFIED:
DIMENSIONS ARE IN **CENTIMETERS**

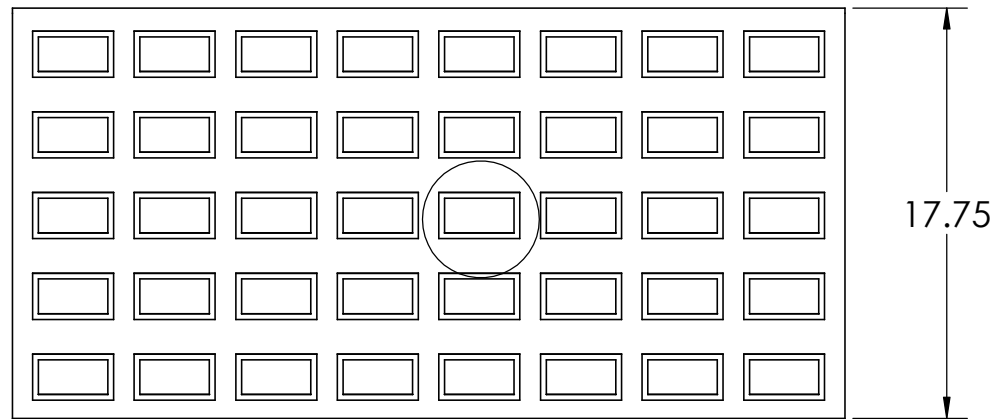

B

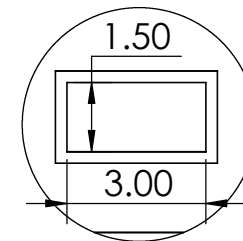
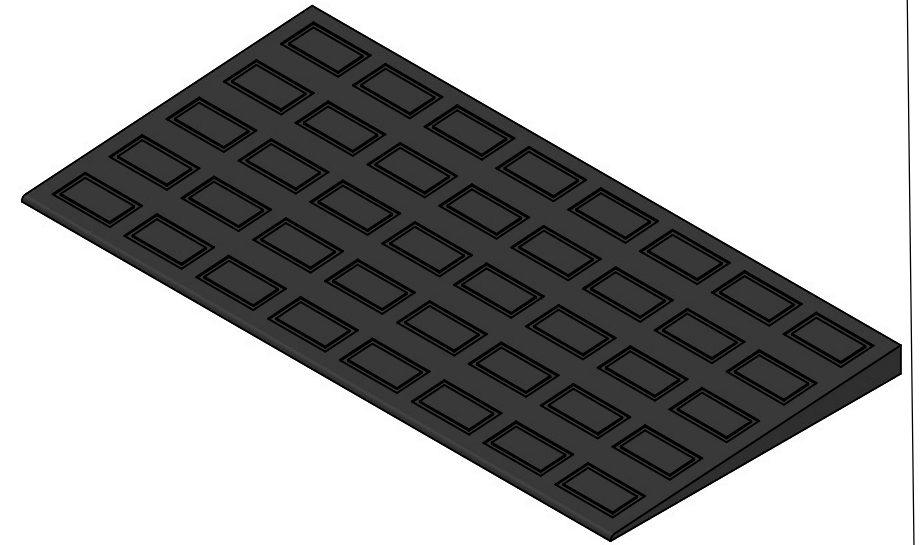

DETAIL B

SCALE 2 : 7

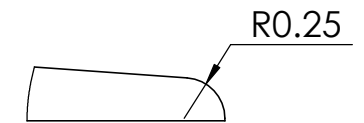

DETAIL A

SCALE 1 : 1

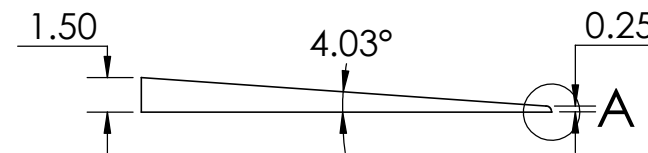
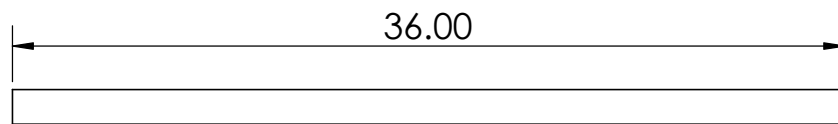

MEDAccess Inc.

Phone & Text **828-264-4085**

E-mail: medaccess@medaccessinc.com

Website: www.medaccessinc.com

RAMP
MODEL:

MRED 700

RAMP
HEIGHT:

1.5 INCHES

LAST
UPDATE:

8/17/20

UNLESS OTHERWISE SPECIFIED:
DIMENSIONS ARE IN **INCHES**

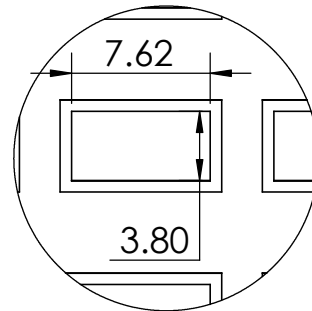
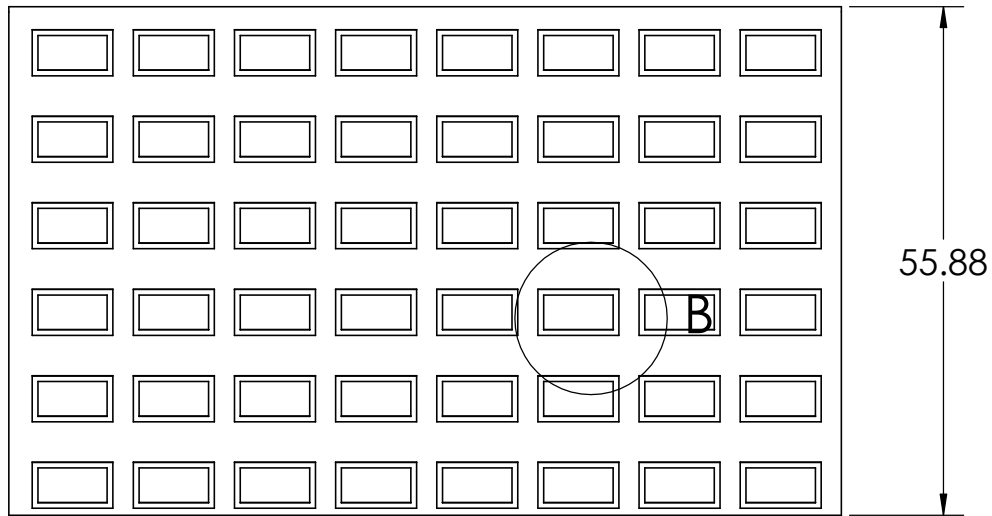

DETAIL B
SCALE 2 : 7

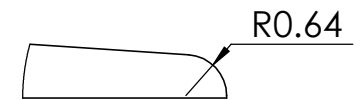
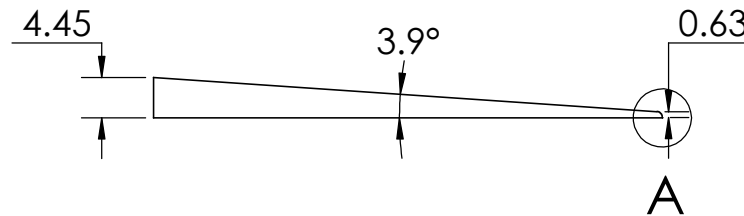
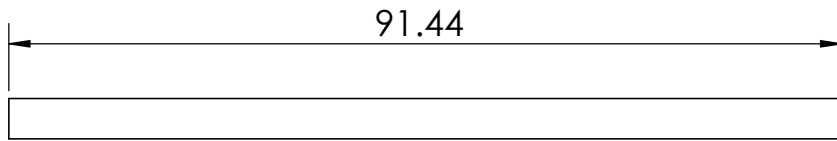
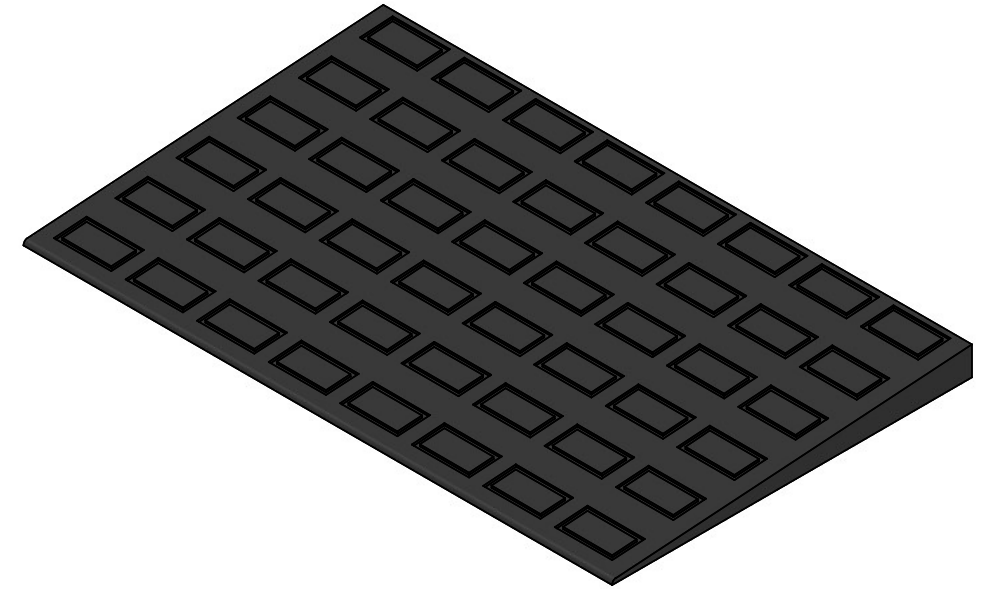

DETAIL A
SCALE 1 : 1



MEDAccess Inc.

Phone & Text **828-264-4085**

E-mail: medaccess@medaccessinc.com

Website: www.medaccessinc.com

RAMP
MODEL:

MRED 800

RAMP
HEIGHT:

4.45 CM

LAST
UPDATE:

11/10/20

UNLESS OTHERWISE SPECIFIED:
DIMENSIONS ARE IN **CENTIMETERS**

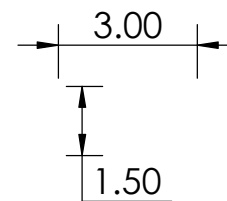
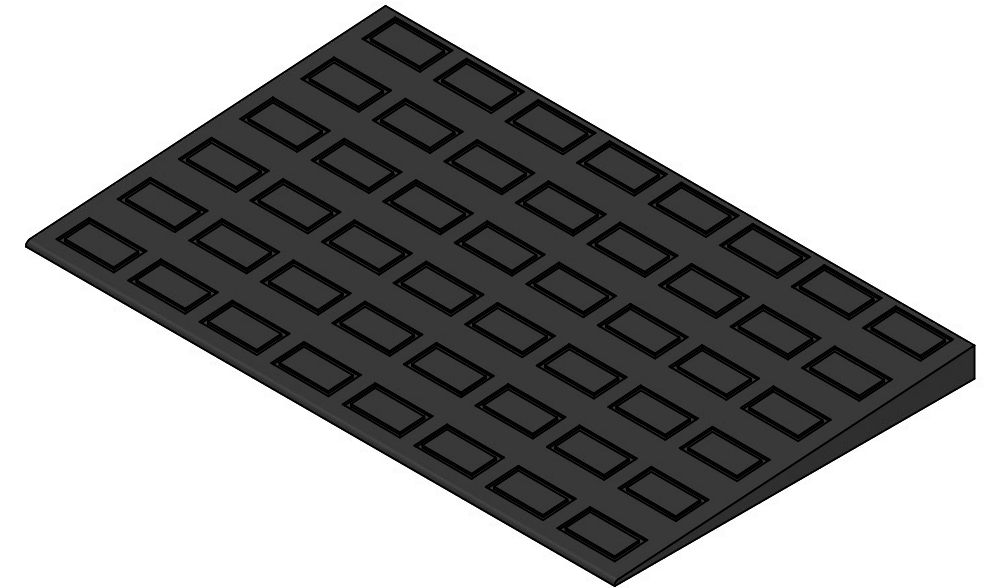
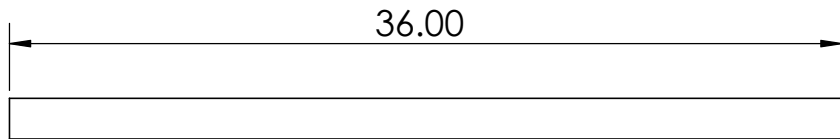
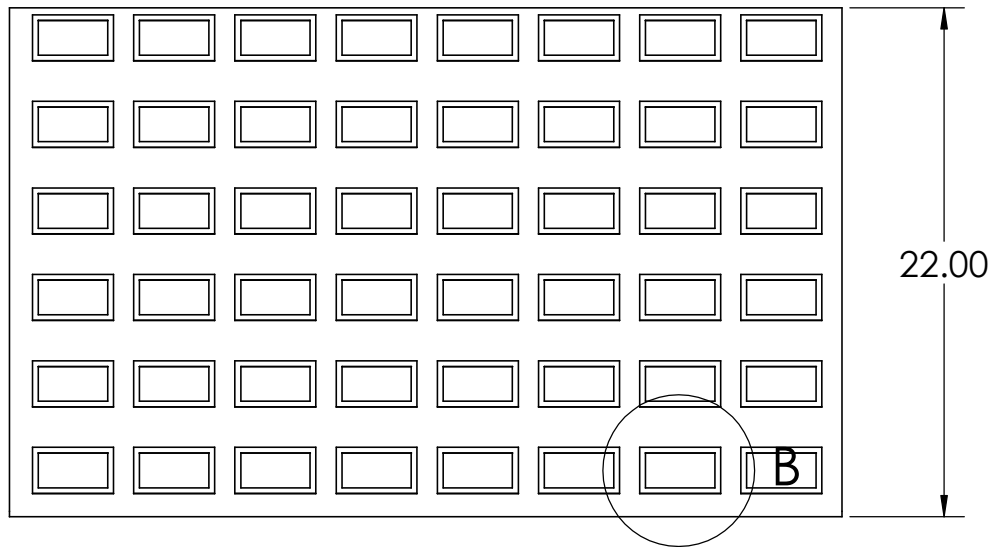

DETAIL B
SCALE 2 : 7

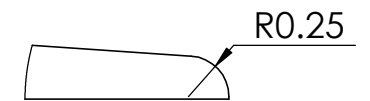

DETAIL A
SCALE 1 : 1

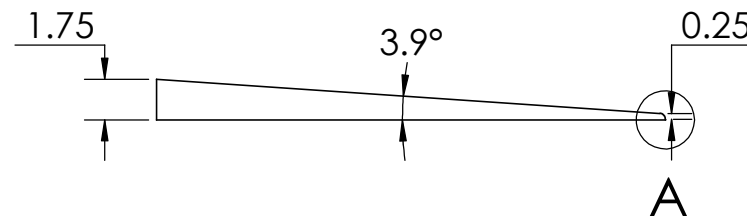

MEDAccess Inc.

Phone & Text **828-264-4085**

E-mail: medaccess@medaccessinc.com

Website: www.medaccessinc.com

RAMP
MODEL:

REDUCER 800

RAMP
HEIGHT:

1.75 INCHES

LAST
UPDATE: 8/17/20

UNLESS OTHERWISE SPECIFIED:
DIMENSIONS ARE IN **INCHES**

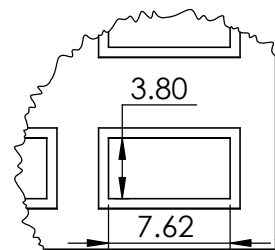
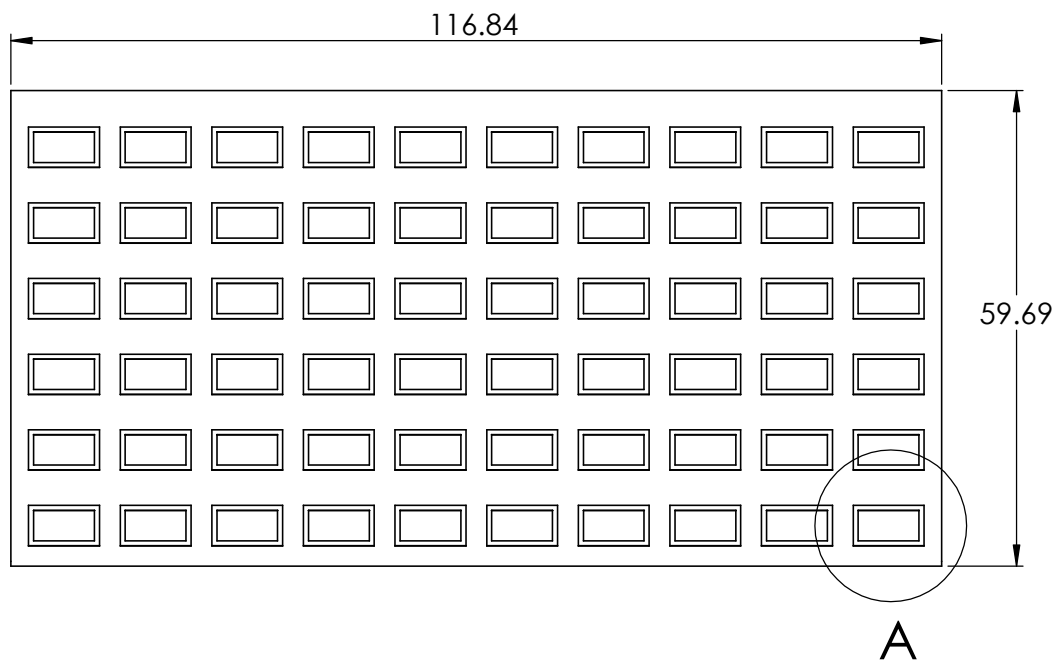

DETAIL A
SCALE 1 : 4

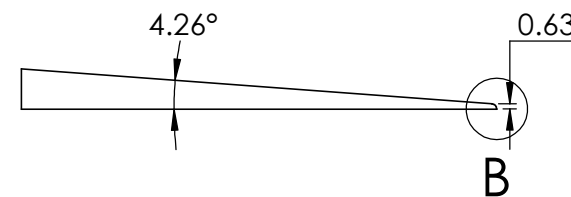
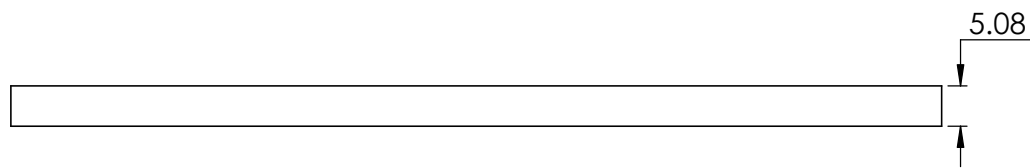
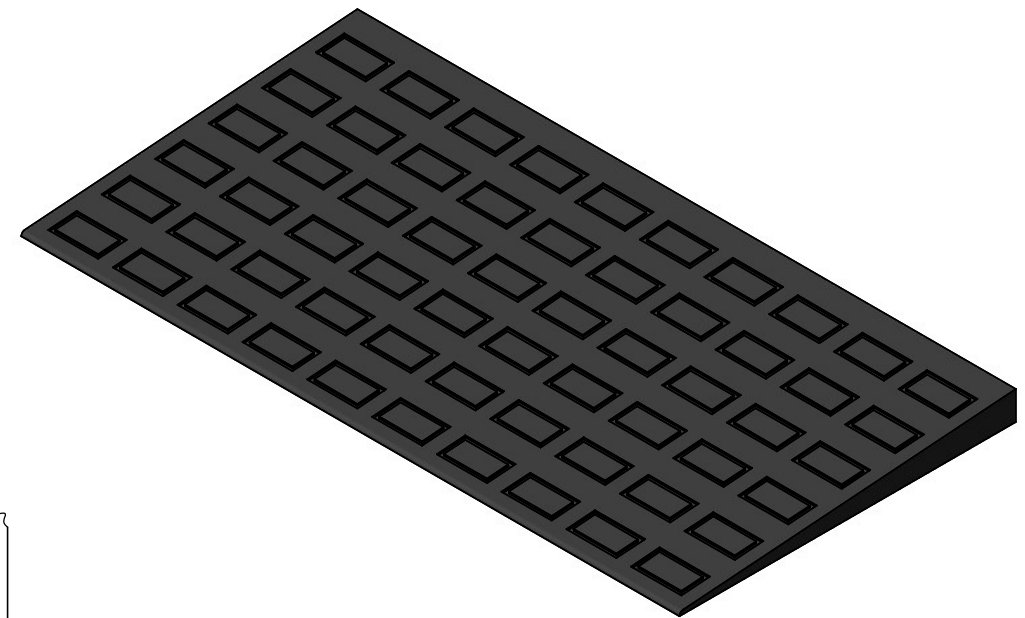

DETAIL B
SCALE 1 : 1



MEDAccess Inc.

Phone & Text **828-264-4085**

E-mail: medaccess@medaccessinc.com

Website: www.medaccessinc.com

RAMP
MODEL:

MRED 850

RAMP
HEIGHT:

5.08 CM

LAST
UPDATE:

11/10/20

UNLESS OTHERWISE SPECIFIED:
DIMENSIONS ARE IN **CENTIMETERS**

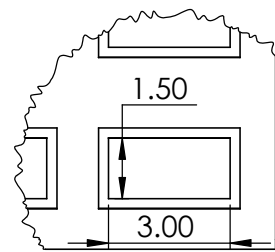
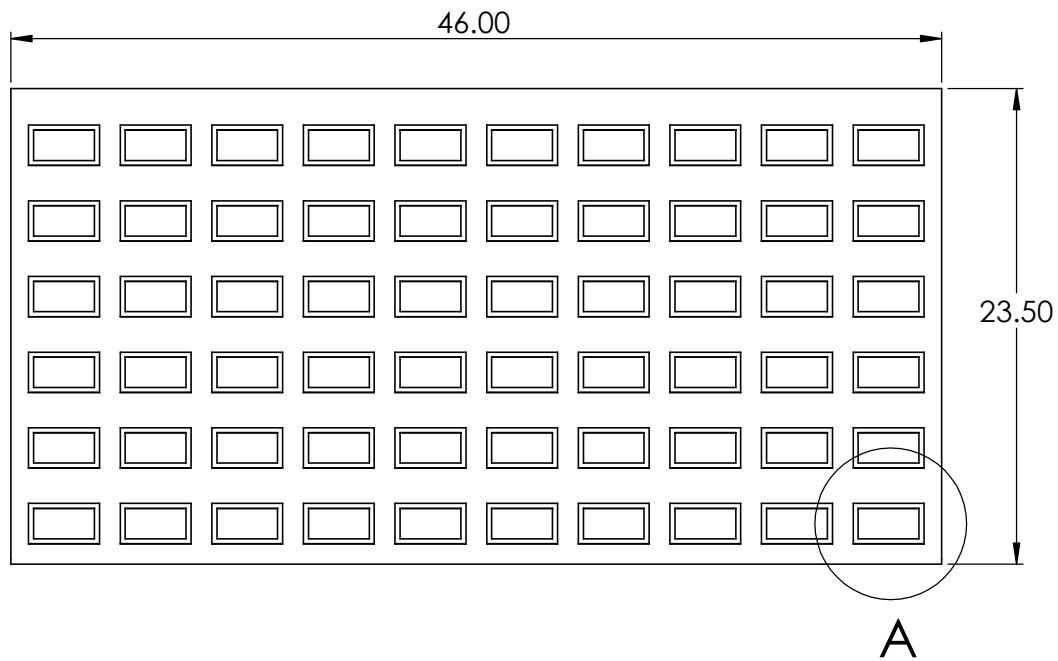

DETAIL A
SCALE 1 : 4

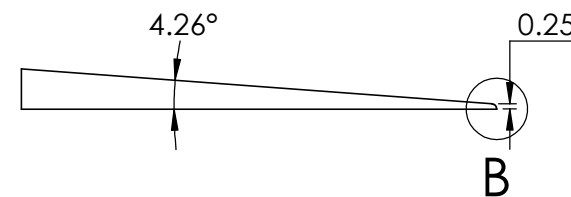
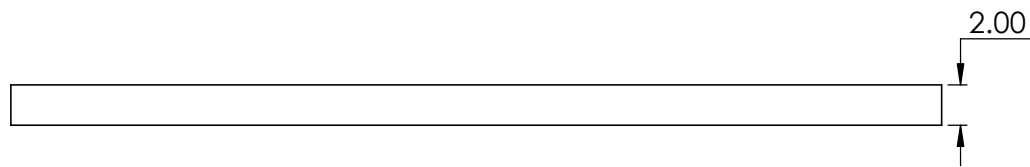
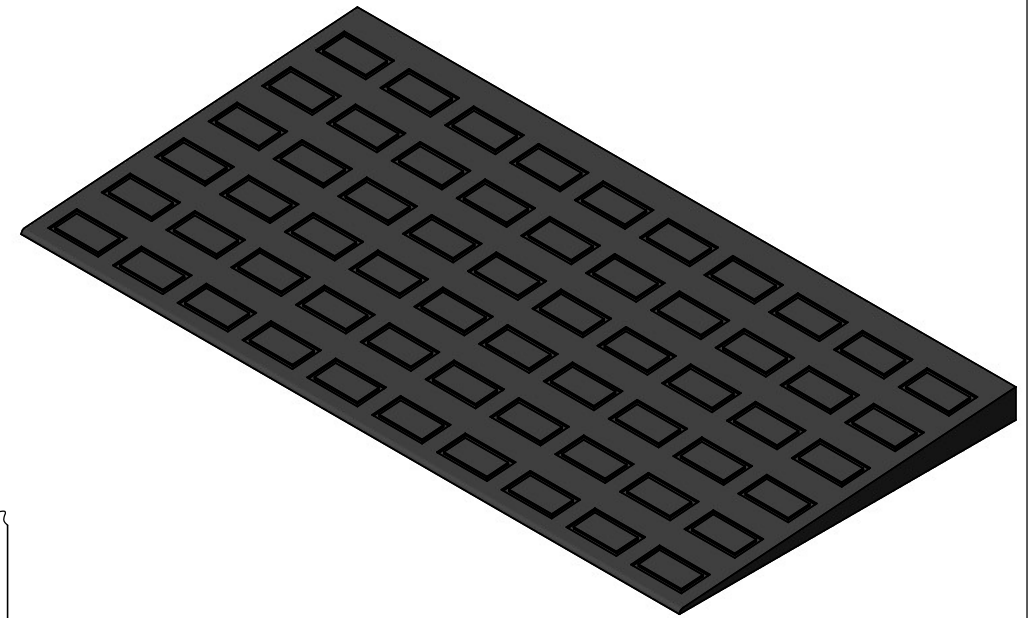

DETAIL B
SCALE 1 : 1



MEDAccess Inc.

Phone & Text **828-264-4085**

E-mail: medaccess@medaccessinc.com

Website: www.medaccessinc.com

RAMP
MODEL:

MRED 850

RAMP
HEIGHT:

2 INCH

LAST
UPDATE:

11/10/20

UNLESS OTHERWISE SPECIFIED:
DIMENSIONS ARE IN **INCHES**

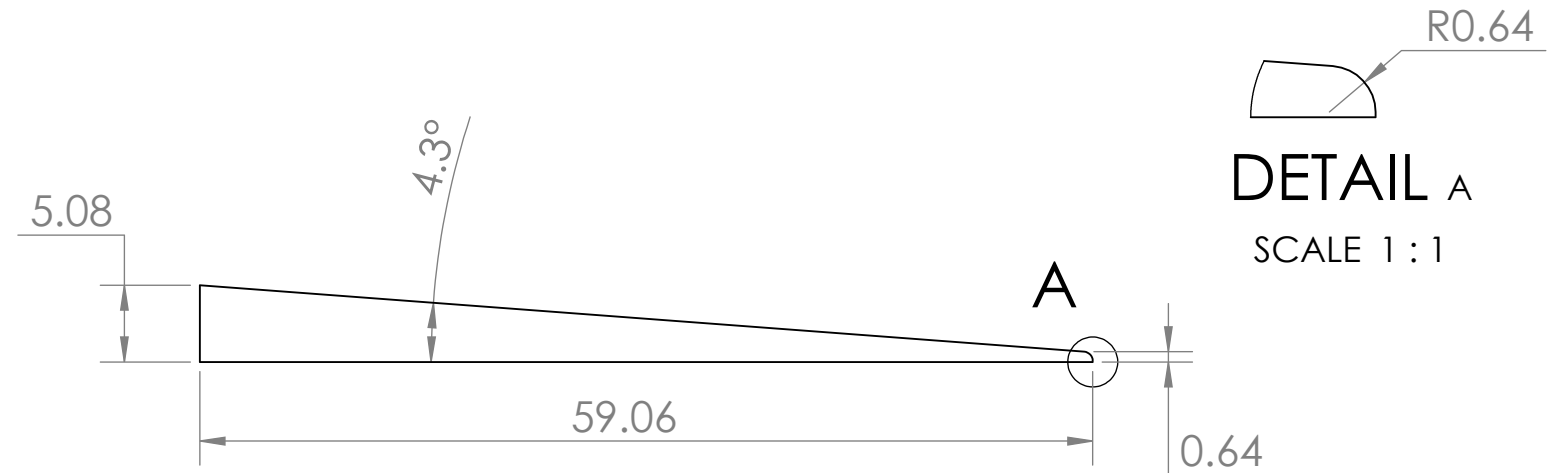
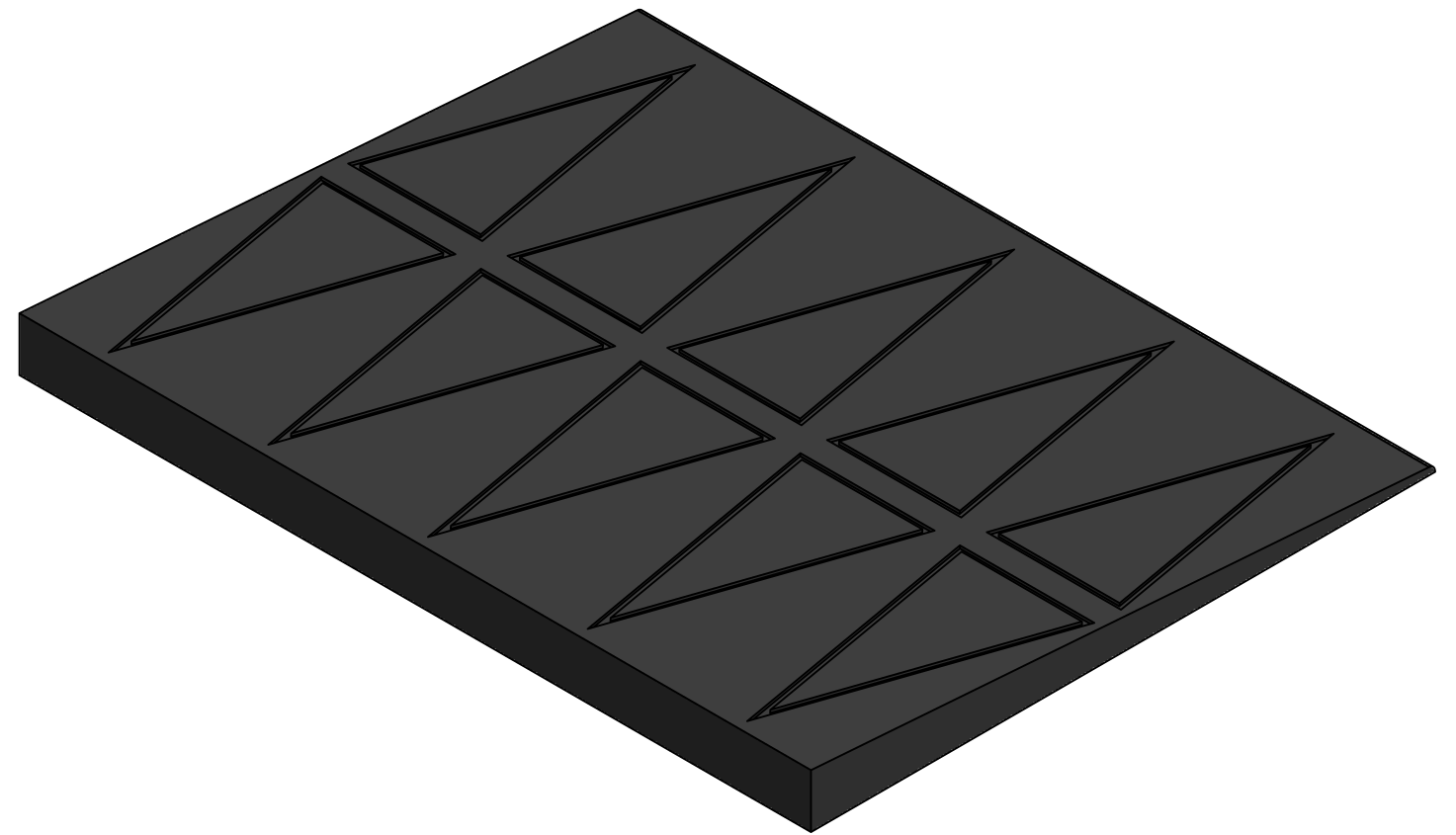
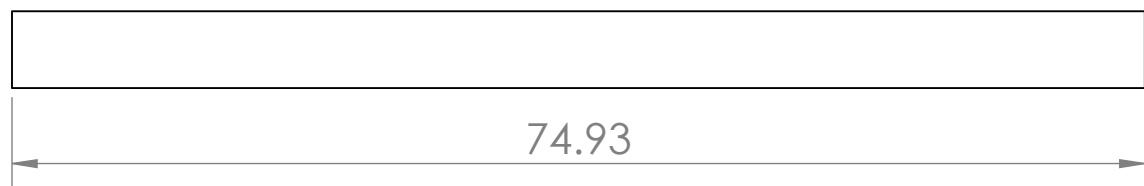
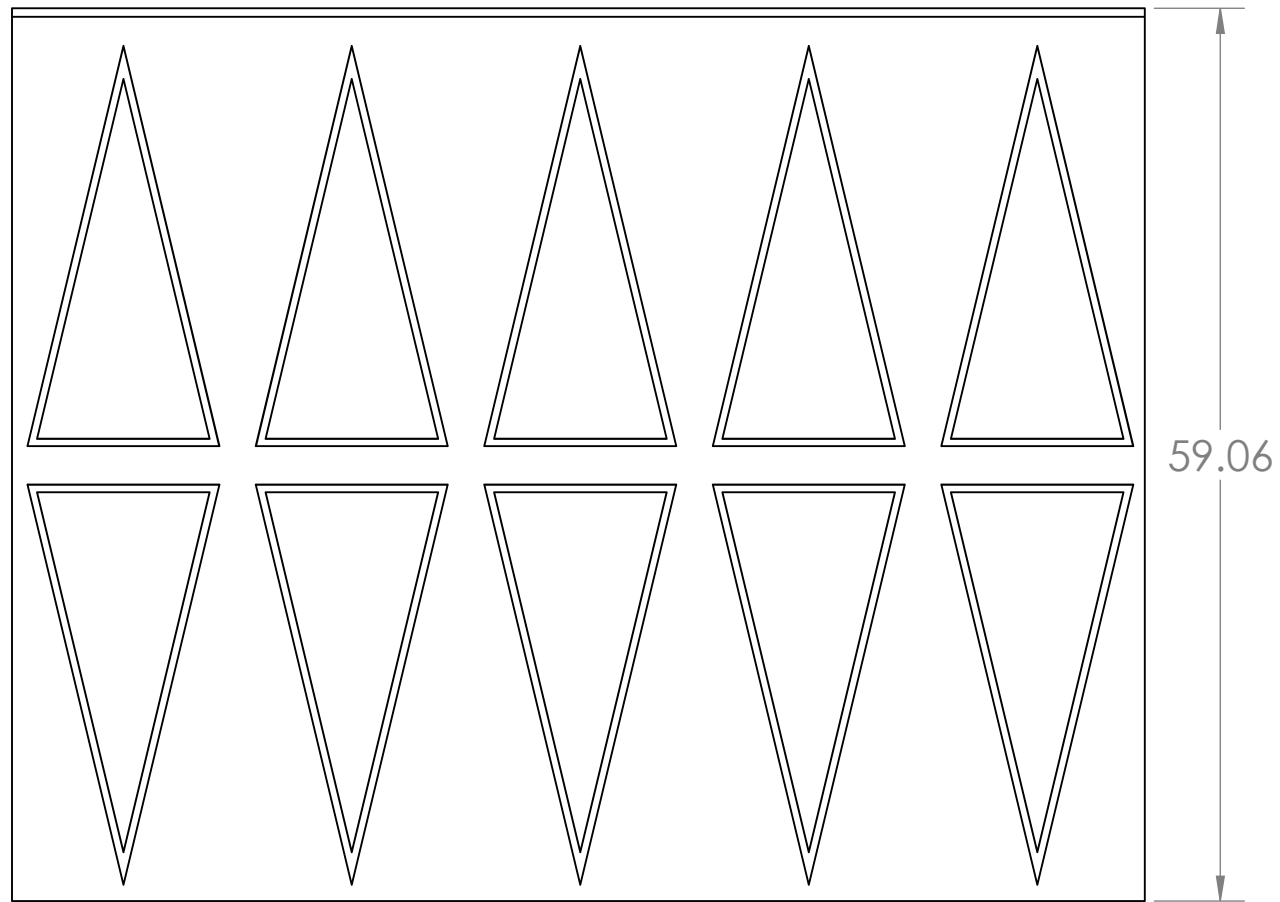

MEDAccess Inc.

Phone & Text **828-264-4085**

E-mail: medaccess@medaccessinc.com

Website: www.medaccessinc.com

RAMP MODEL:	REDUCER 900
RAMP HEIGHT:	5.08 CM
LAST UPDATE:	11/10/20
UNLESS OTHERWISE SPECIFIED: DIMENSIONS ARE IN CENTIMETERS	

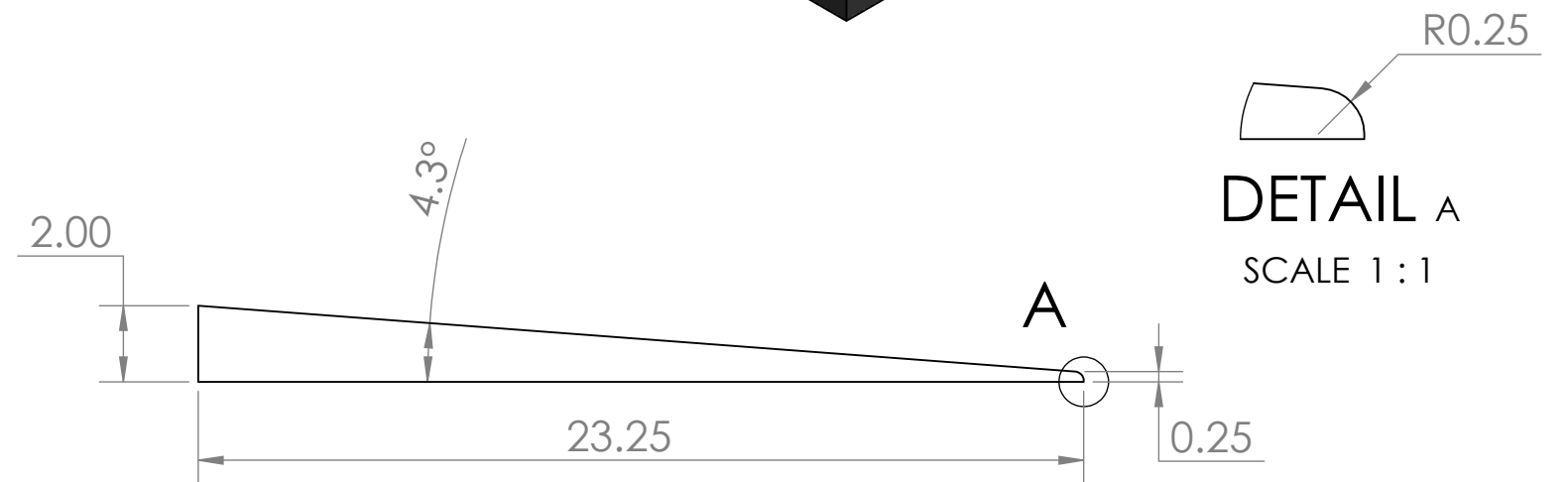
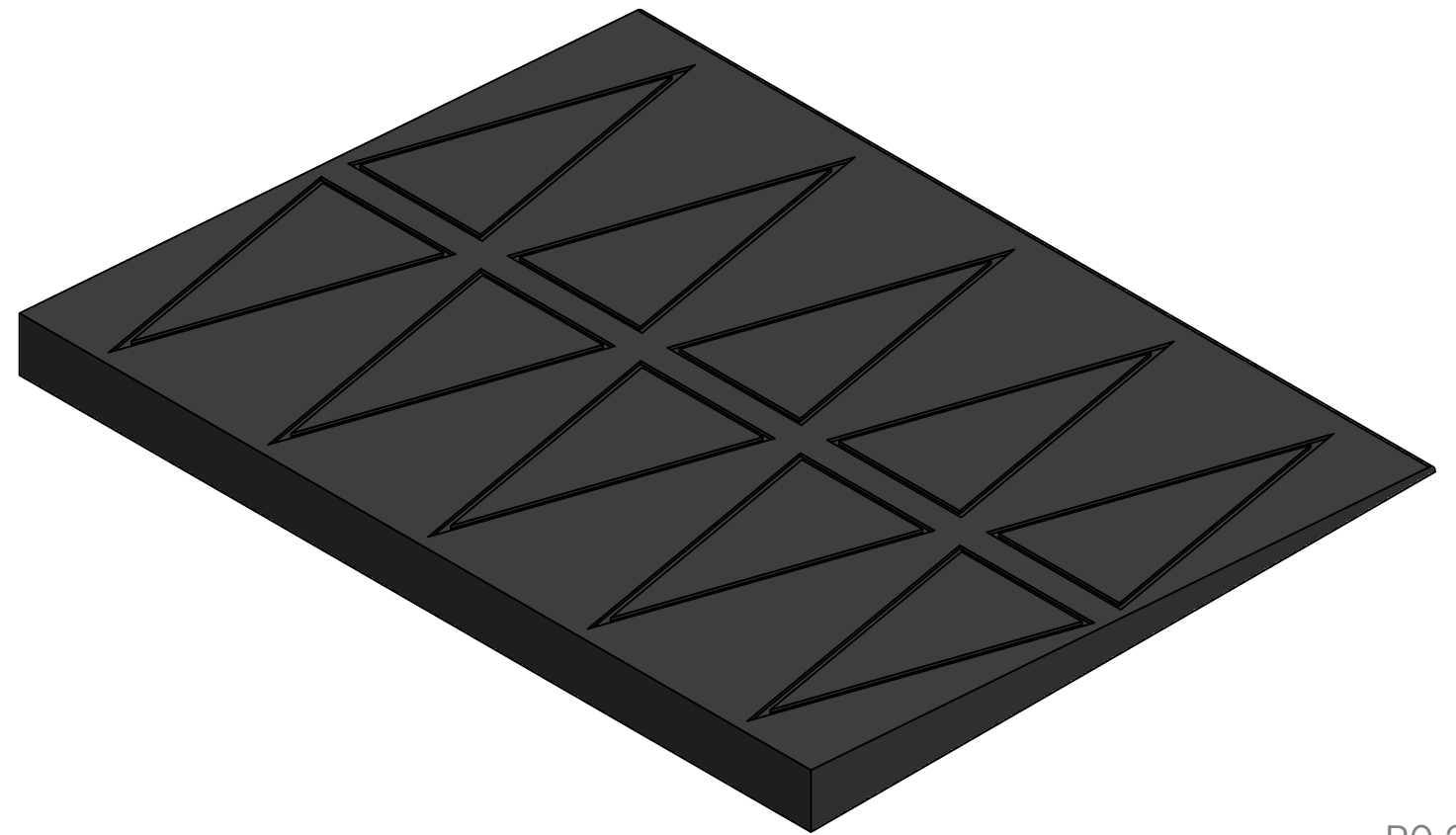
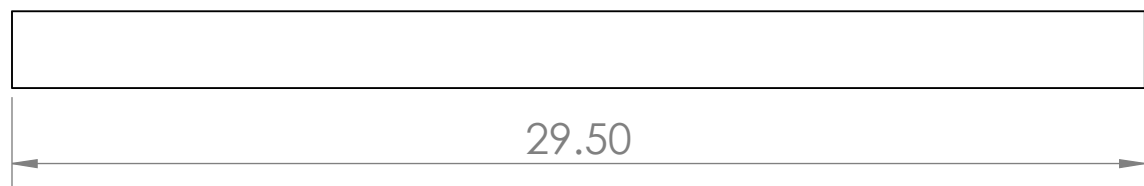
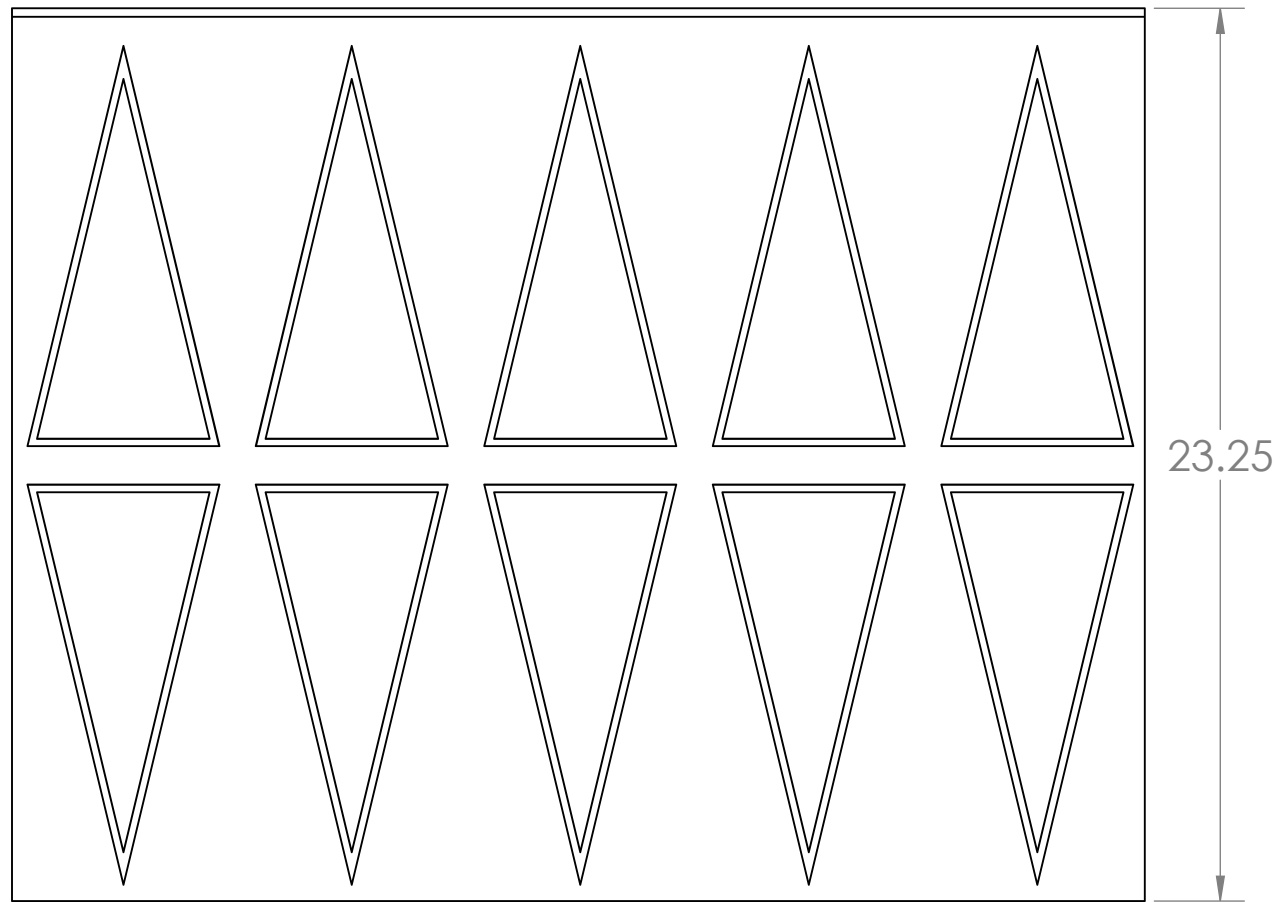

MEDAccess Inc.

Phone & Text **828-264-4085**

E-mail: medaccess@medaccessinc.com

Website: www.medaccessinc.com

RAMP
MODEL:

REDUCER 900

RAMP
HEIGHT:

2 INCHES

LAST
UPDATE: 11/10/20

UNLESS OTHERWISE SPECIFIED:
DIMENSIONS ARE IN **INCHES**

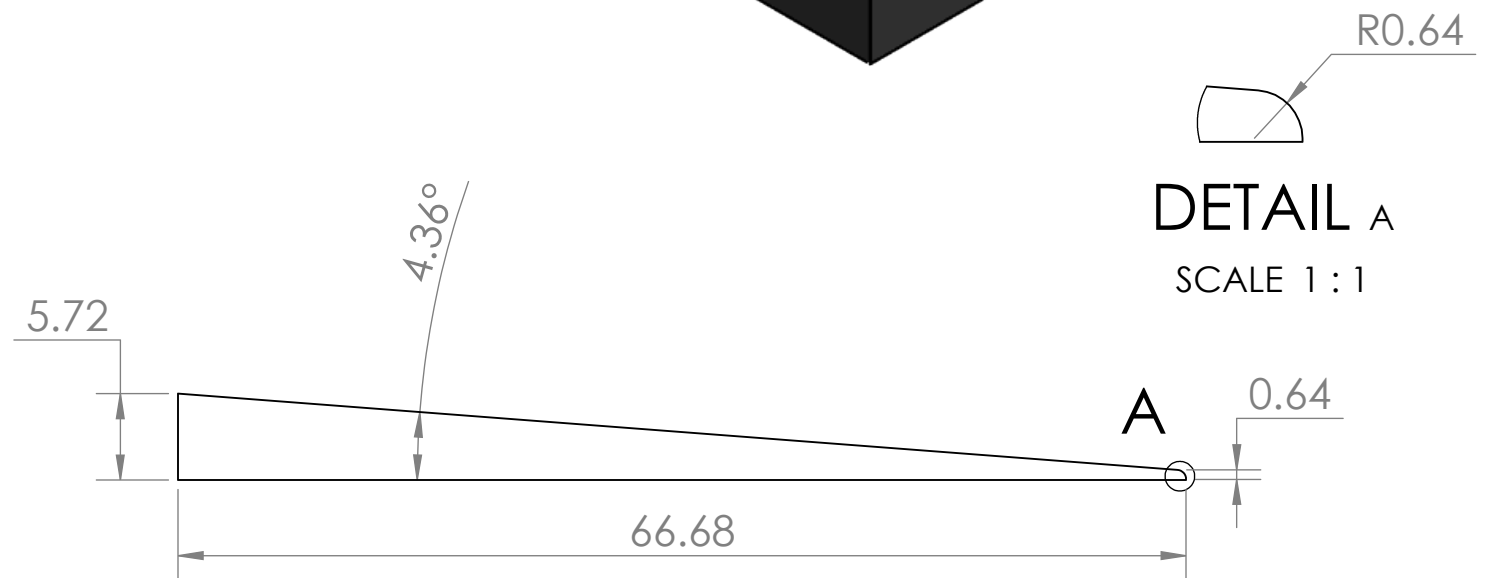
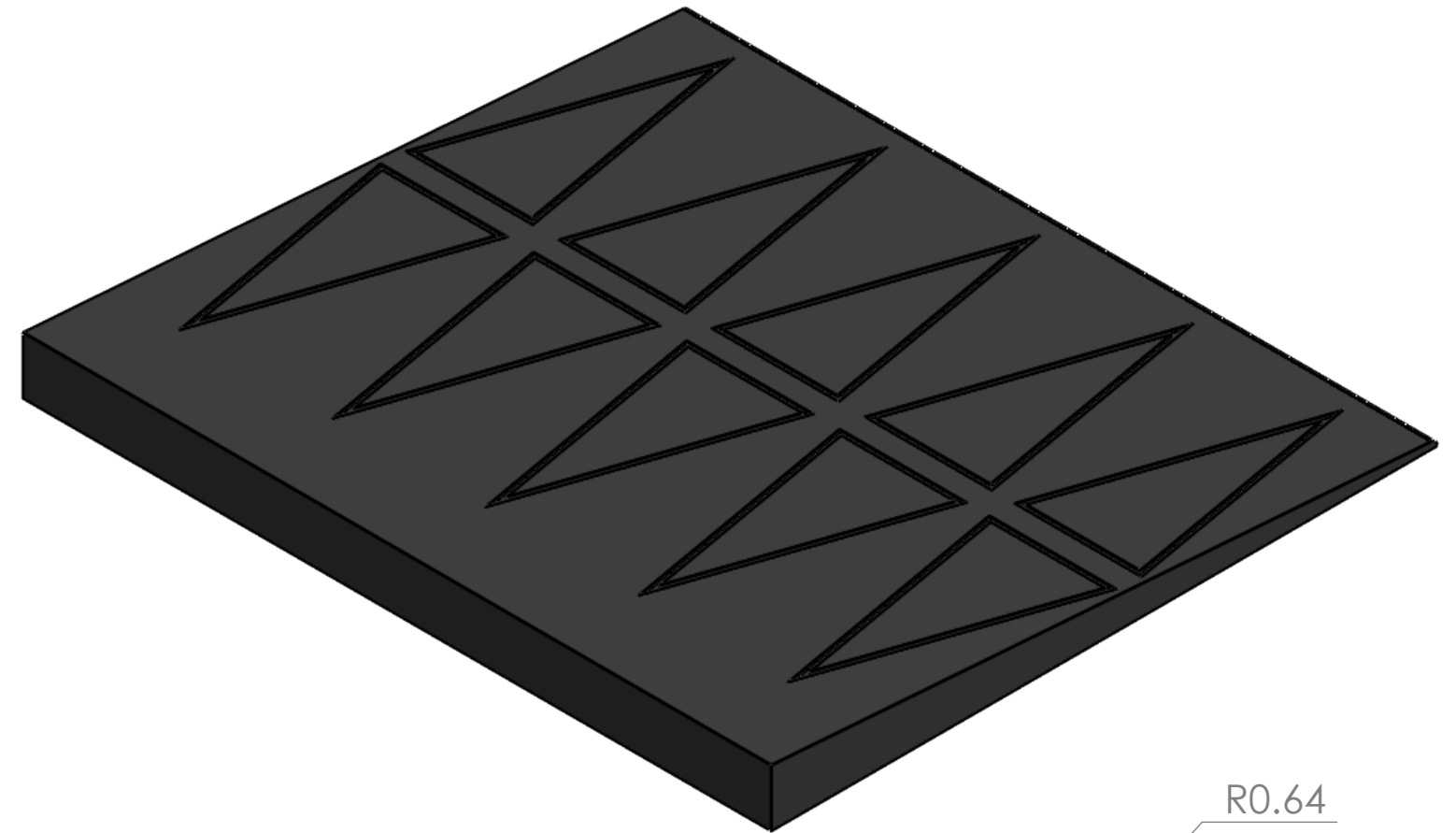
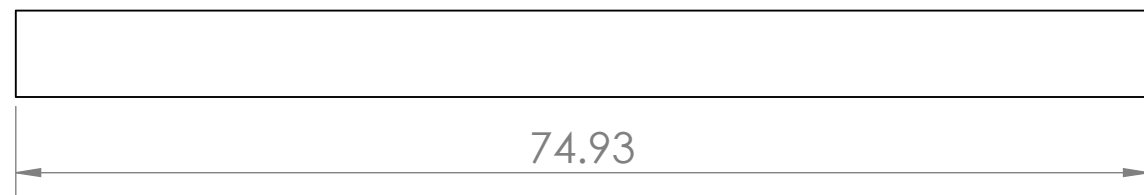
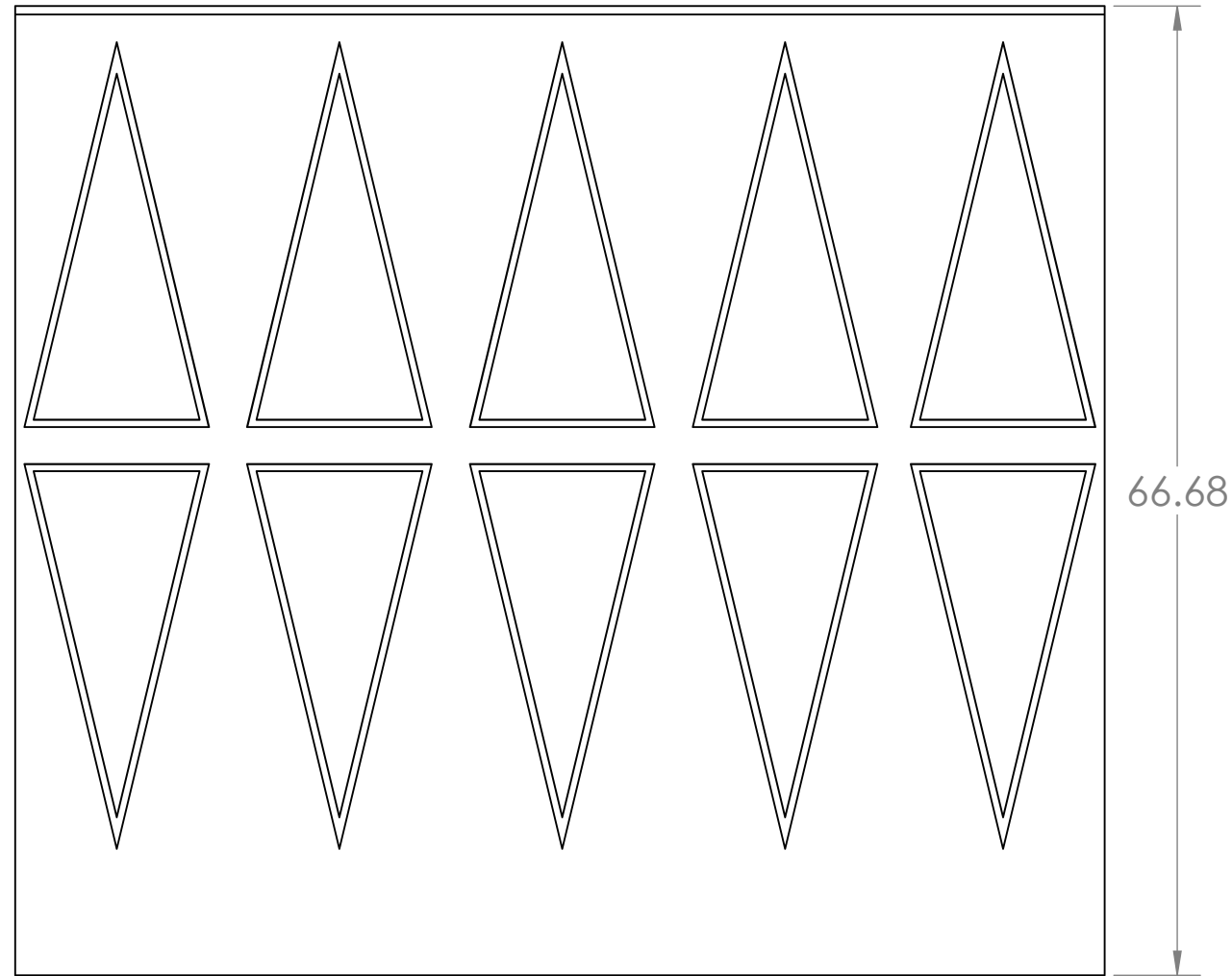

MEDAccess Inc.

Phone & Text **828-264-4085**

E-mail: medaccess@medaccessinc.com

Website: www.medaccessinc.com

RAMP
MODEL:

REDUCER 1000

RAMP
HEIGHT:

5.72 CM

LAST
UPDATE: 11/10/20

UNLESS OTHERWISE SPECIFIED:
DIMENSIONS ARE IN CENTIMETERS

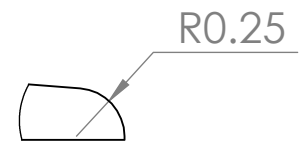
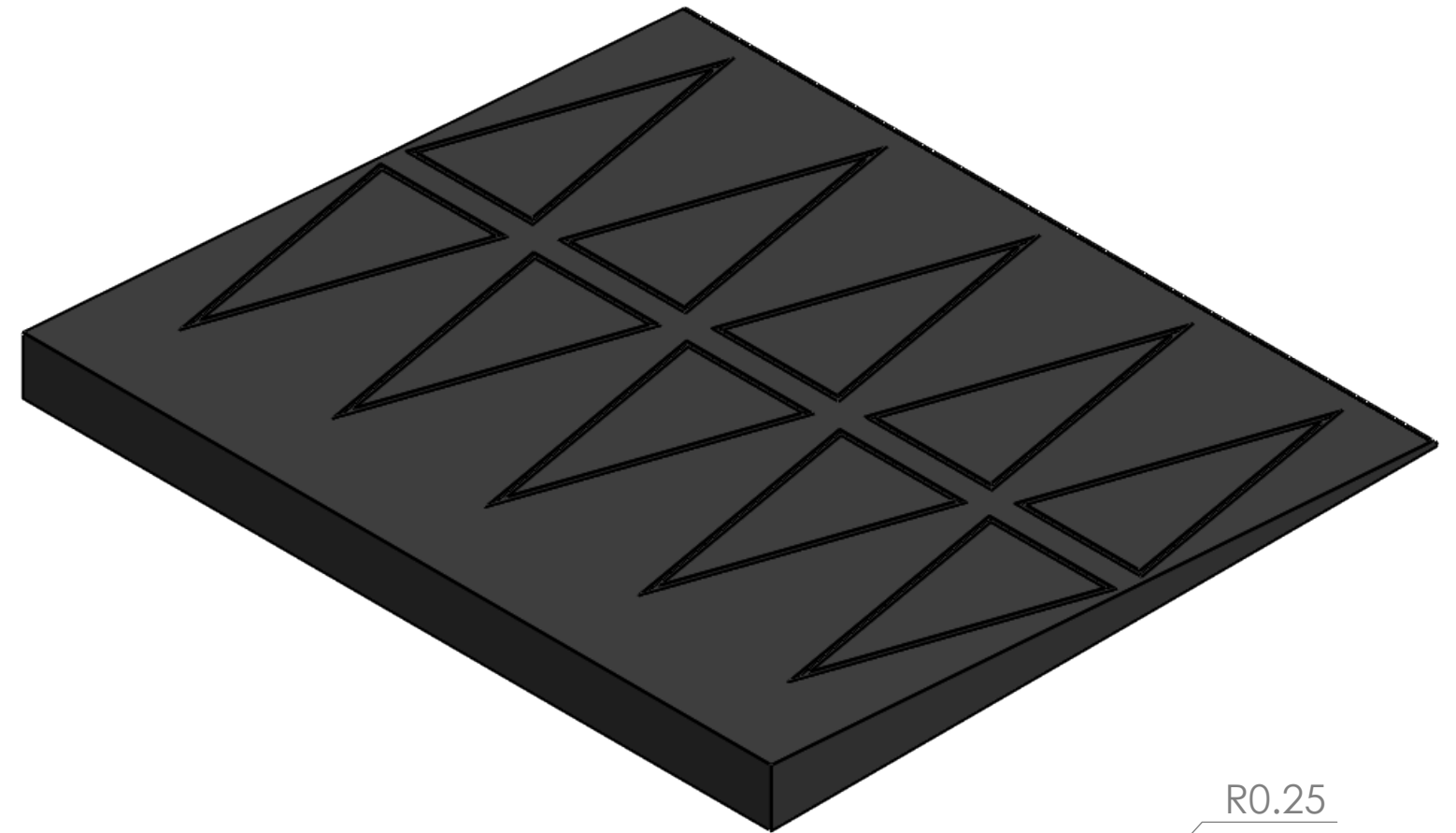
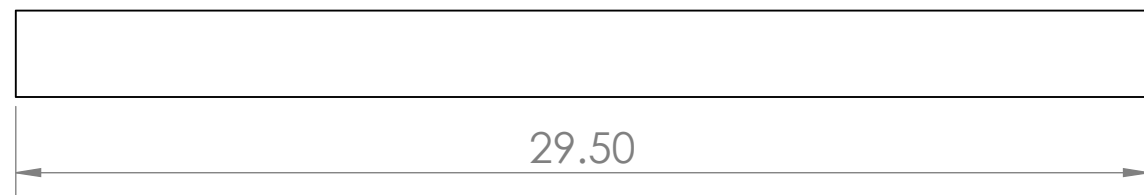
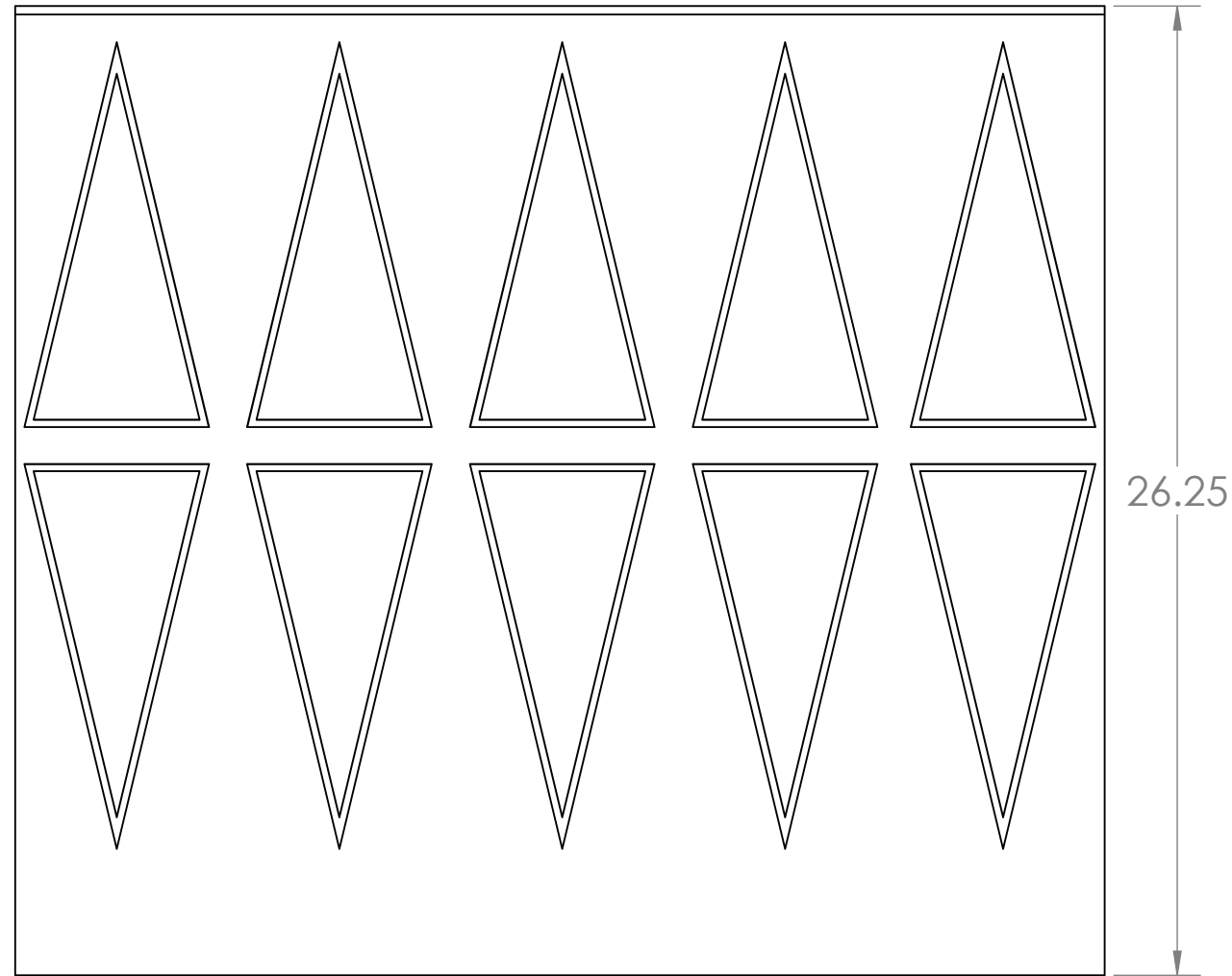

DETAIL A
SCALE 1:1

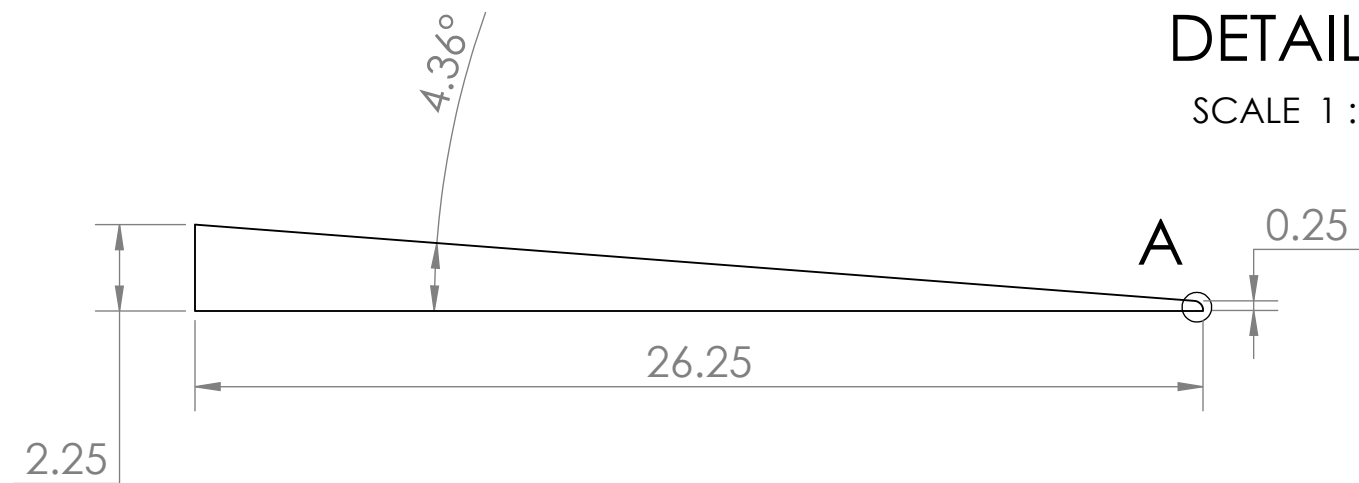

MEDAccess Inc.

Phone & Text **828-264-4085**

E-mail: medaccess@medaccessinc.com

Website: www.medaccessinc.com

RAMP
MODEL:

REDUCER 1000

RAMP
HEIGHT:

2.25 INCHES

AST
PDATE: 11/10/20

UNLESS OTHERWISE SPECIFIED:
DIMENSIONS ARE IN **INCHES**

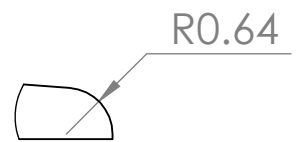
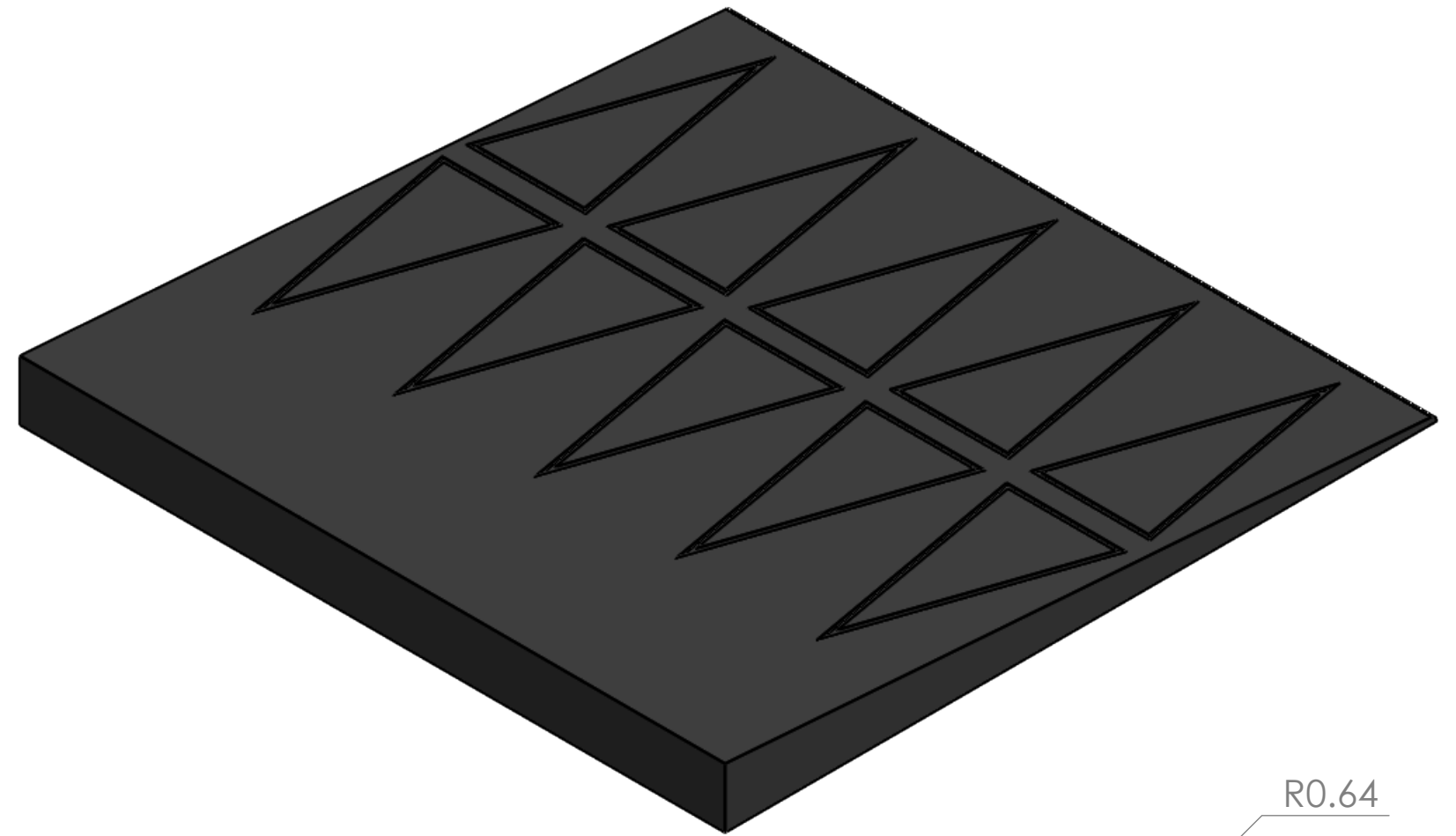
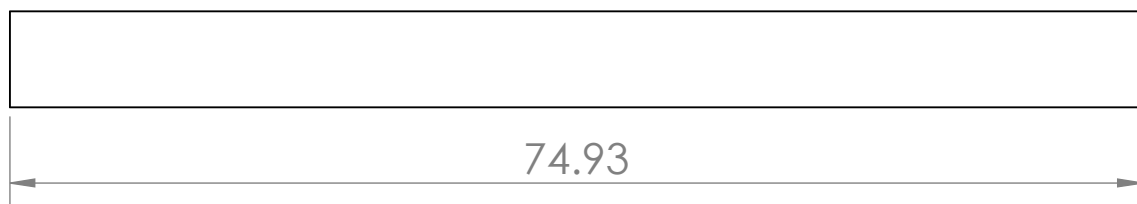
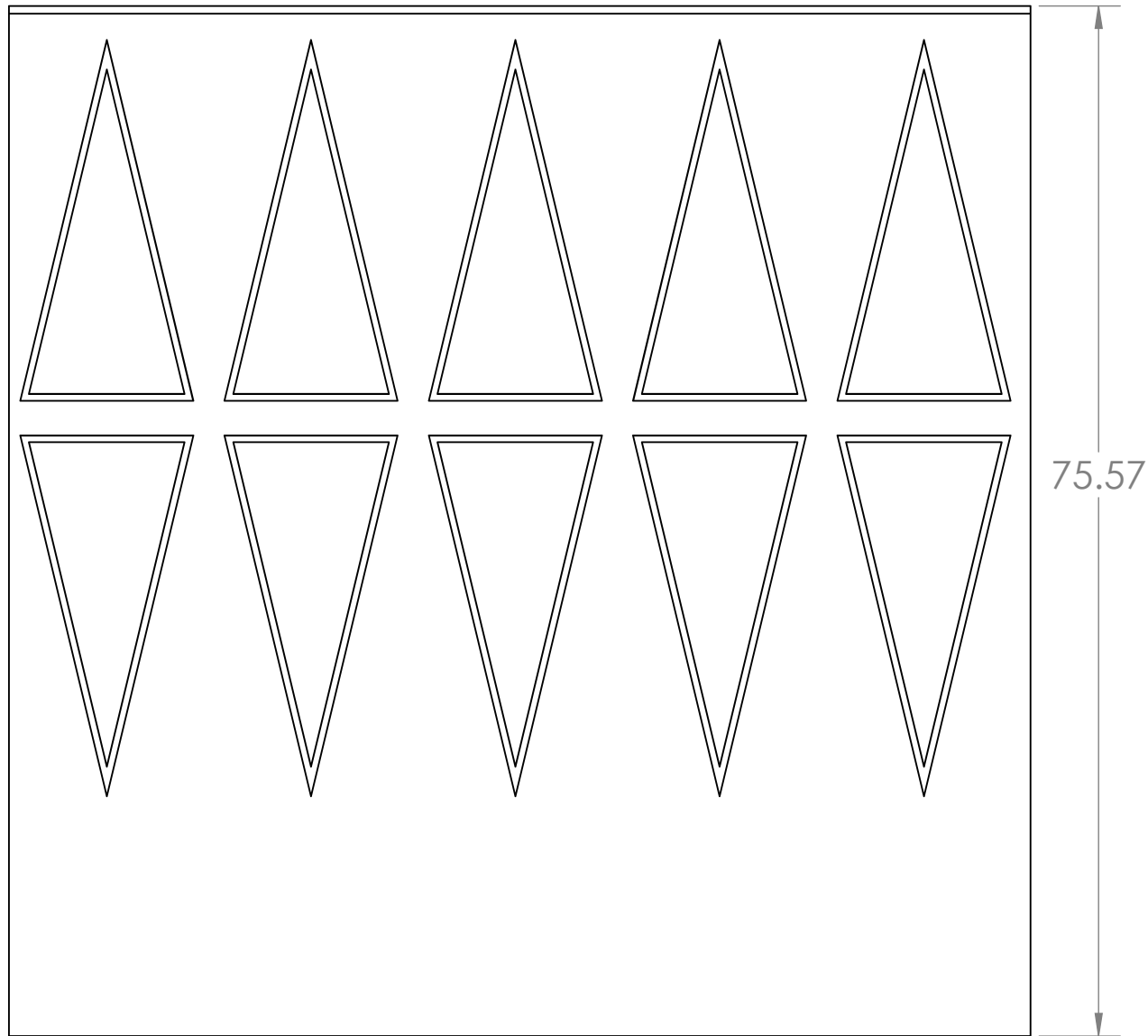

DETAIL A
SCALE 1 : 1

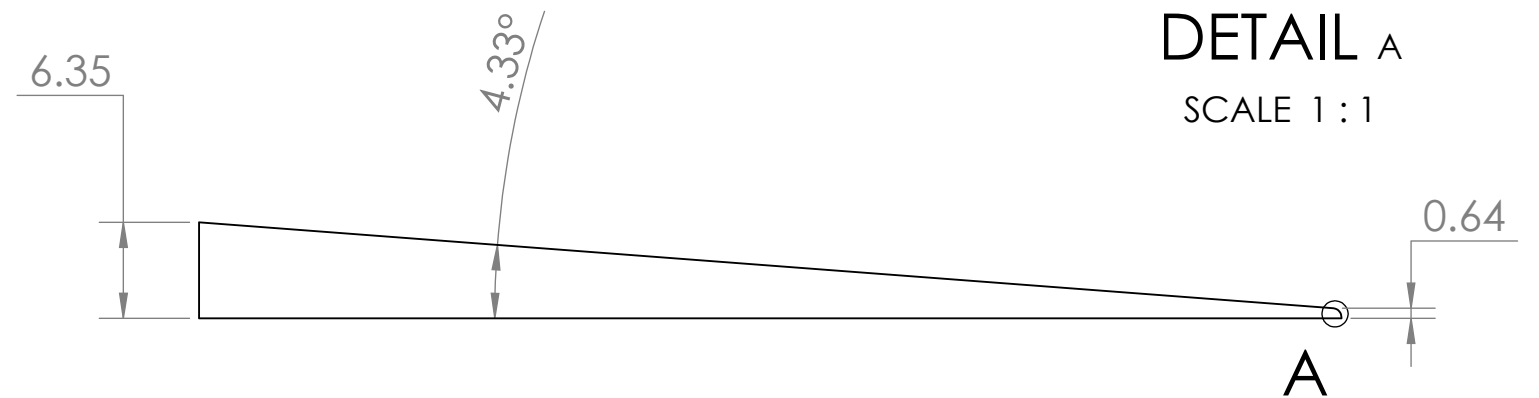

MEDAccess Inc.

Phone & Text **828-264-4085**

E-mail: medaccess@medaccessinc.com

Website: www.medaccessinc.com

RAMP
MODEL:

REDUCER 1200

RAMP
HEIGHT:

6.35 CM

LAST
UPDATE: 11/10/20

UNLESS OTHERWISE SPECIFIED:
DIMENSIONS ARE IN CENTIMETERS

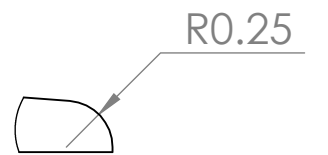
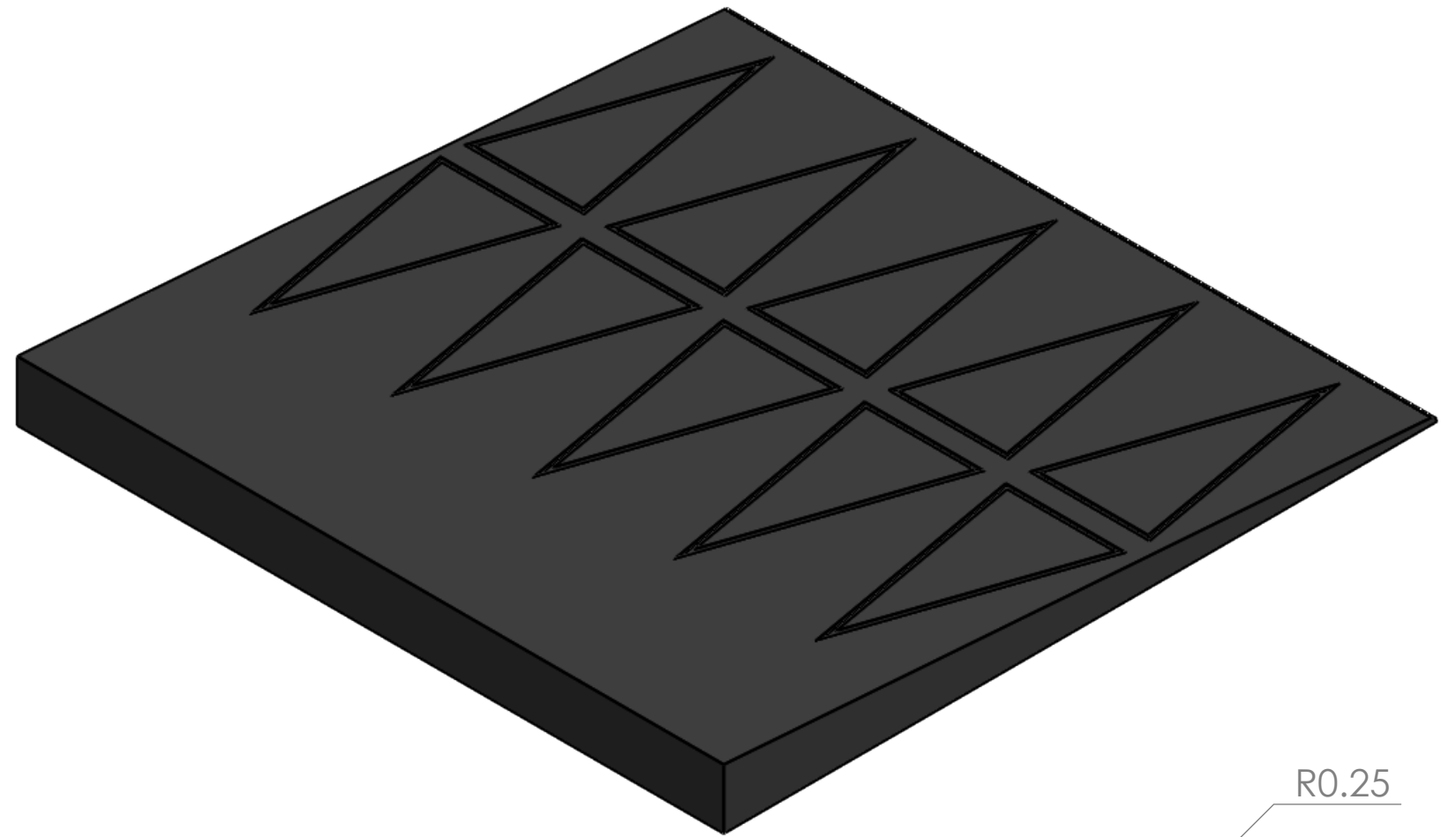
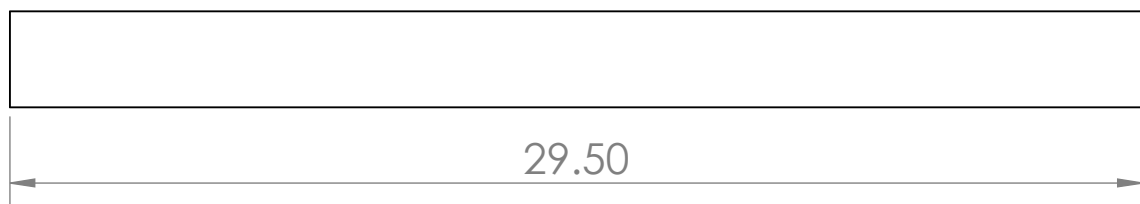
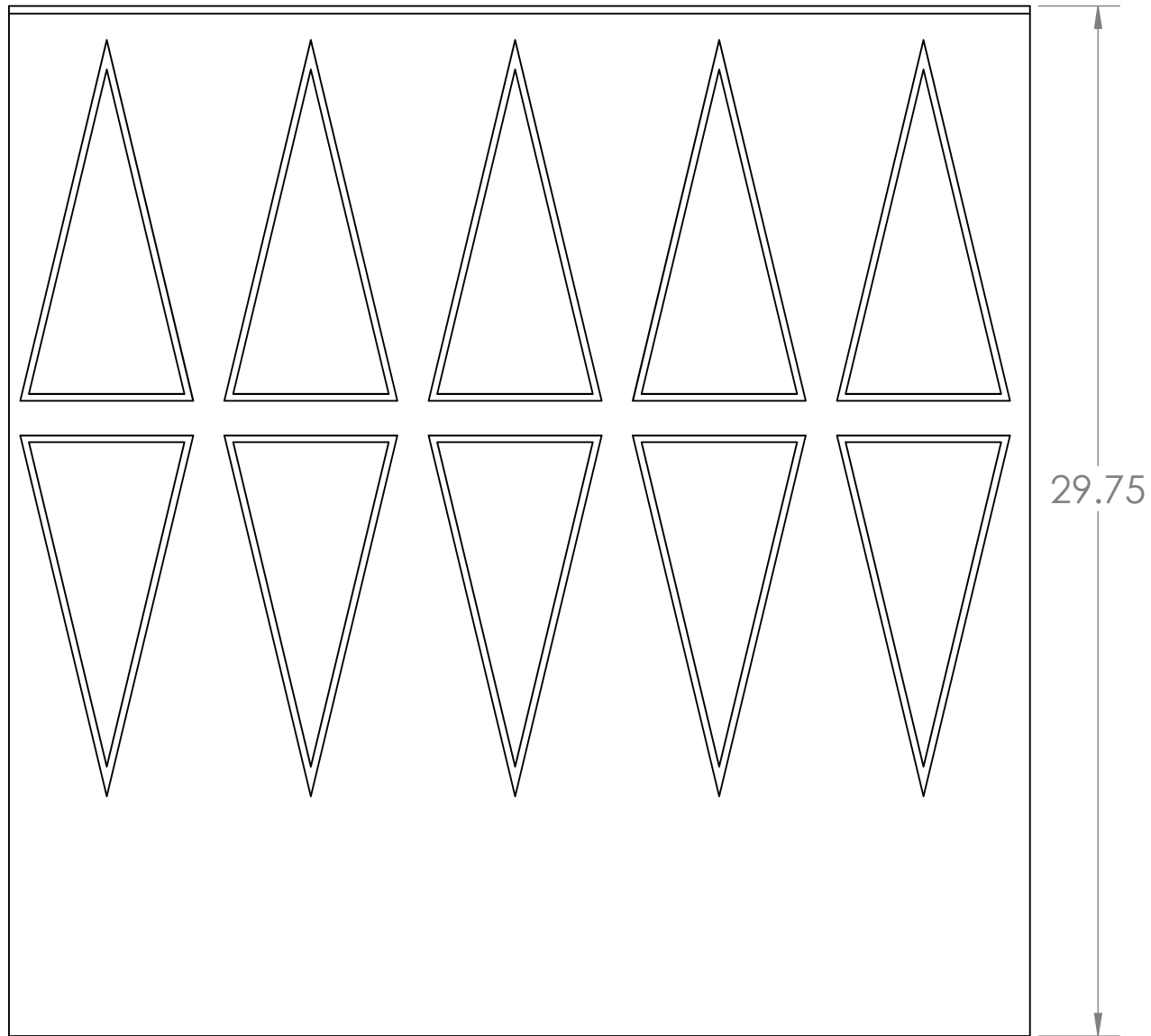

DETAIL A
SCALE 1 : 1

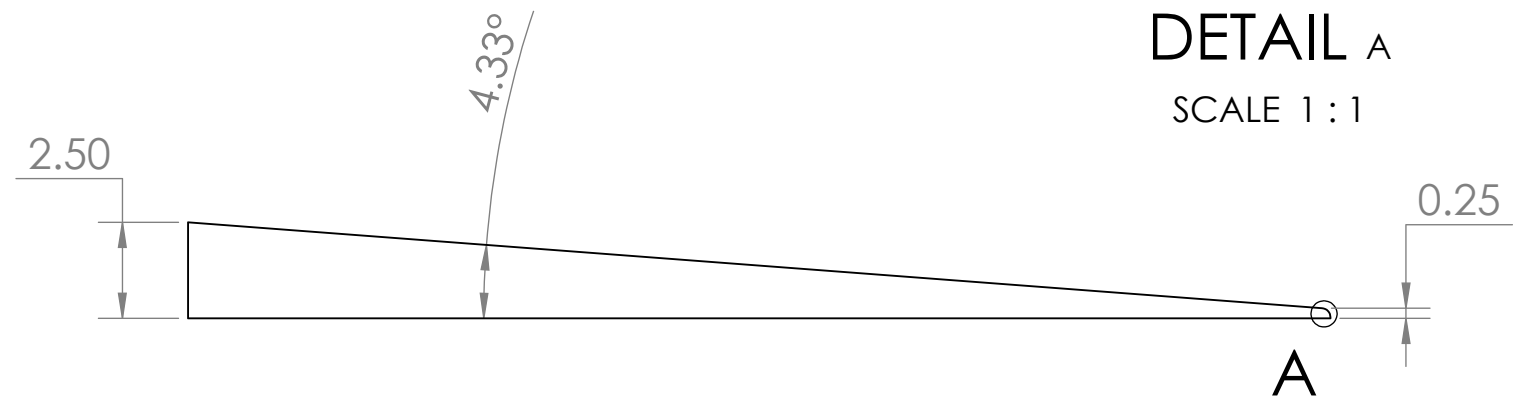

MEDAccess Inc.

Phone & Text **828-264-4085**

E-mail: medaccess@medaccessinc.com

Website: www.medaccessinc.com

RAMP
MODEL:

REDUCER 1200

RAMP
HEIGHT:

2.5 INCHES

LAST
UPDATE: 11/10/20

UNLESS OTHERWISE SPECIFIED:
DIMENSIONS ARE IN **INCHES**

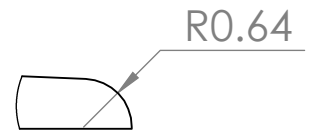
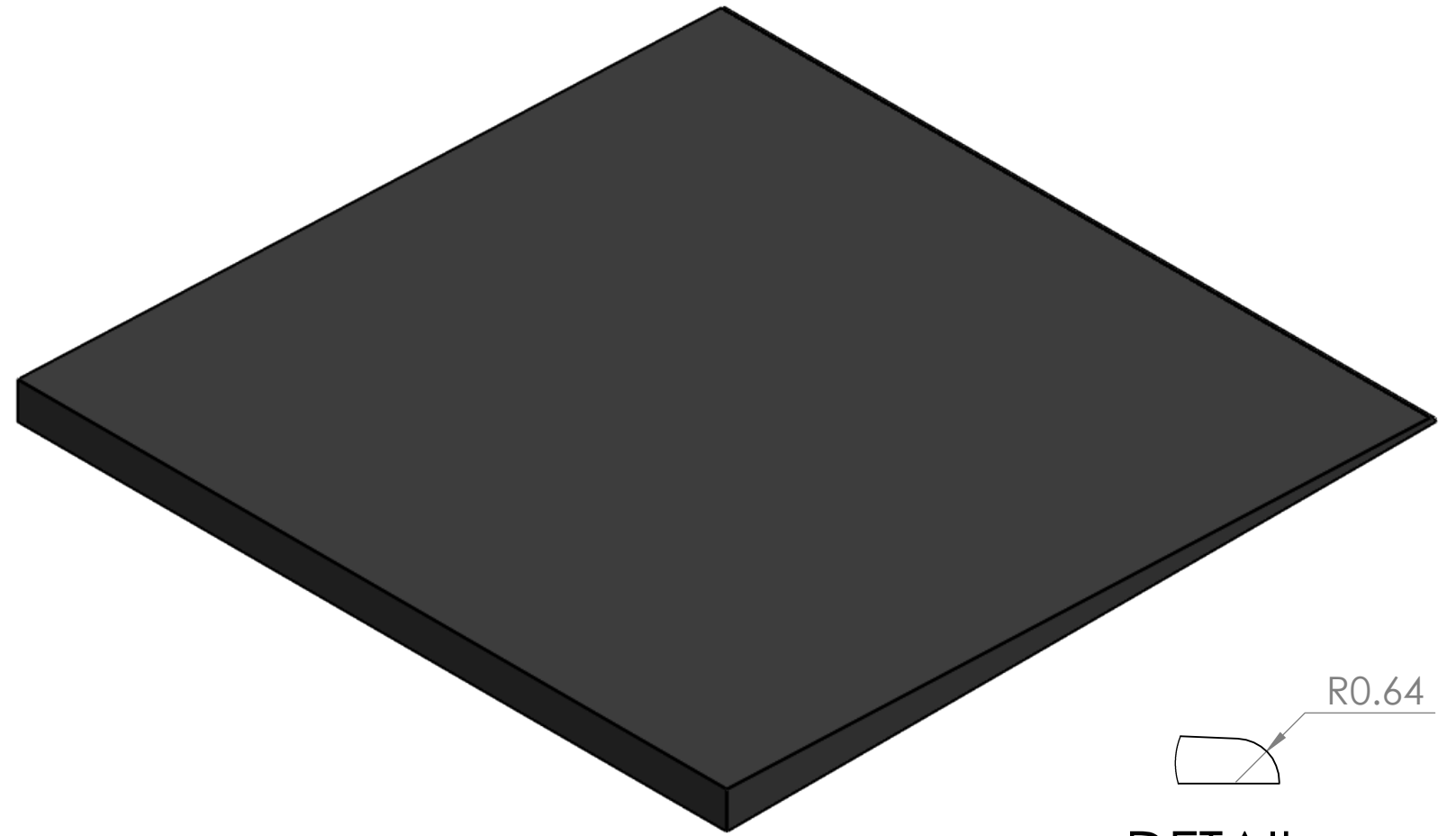
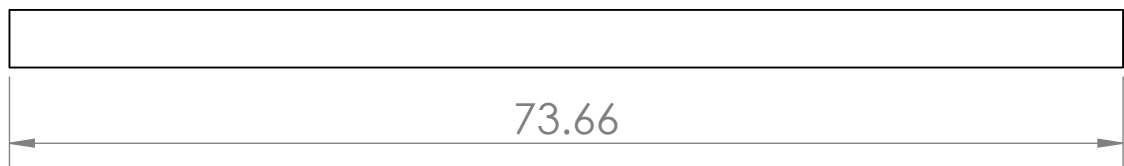

DETAIL A
SCALE 1 : 1

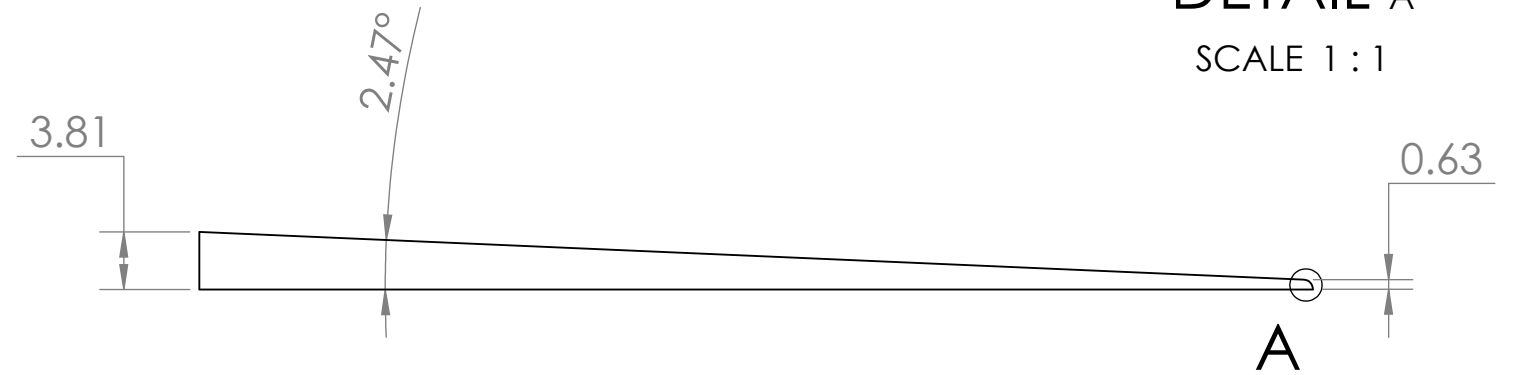

MEDAccess Inc.
 Phone & Text **828-264-4085**
 E-mail: medaccess@medaccessinc.com
 Website: www.medaccessinc.com

RAMP MODEL:	REDUCER 1300
RAMP HEIGHT:	3.81 CM
LAST UPDATE:	11/10/20
UNLESS OTHERWISE SPECIFIED: DIMENSIONS ARE IN CENTIMETERS	

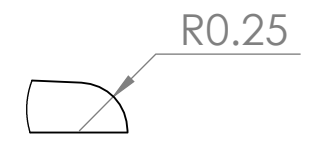
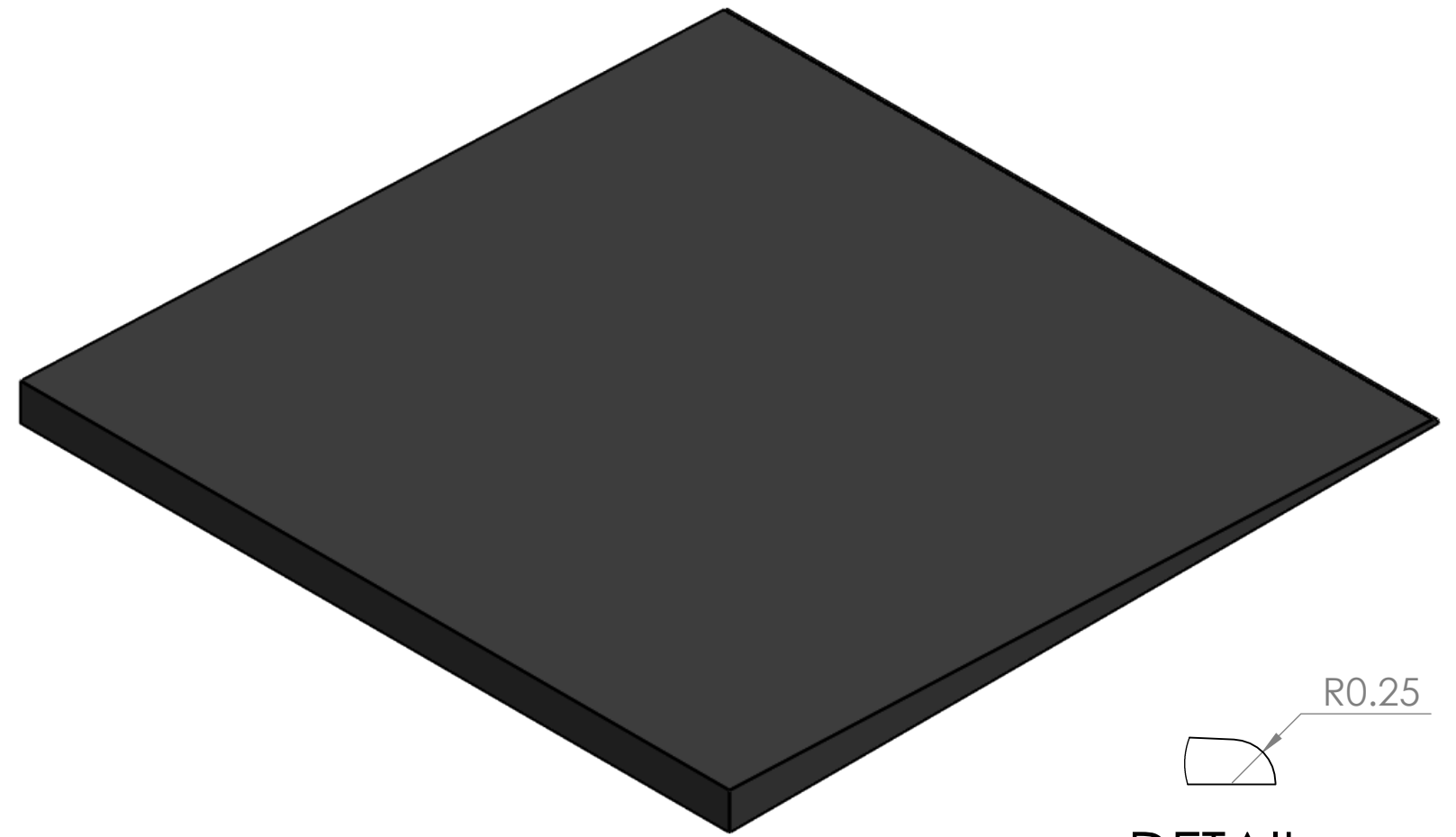
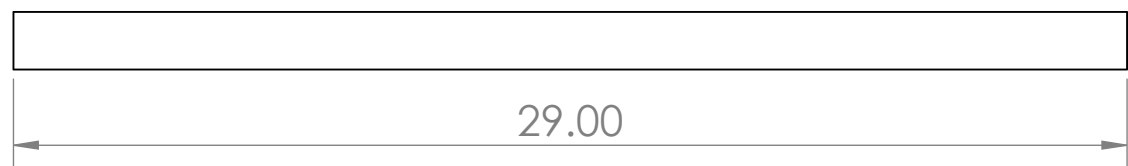
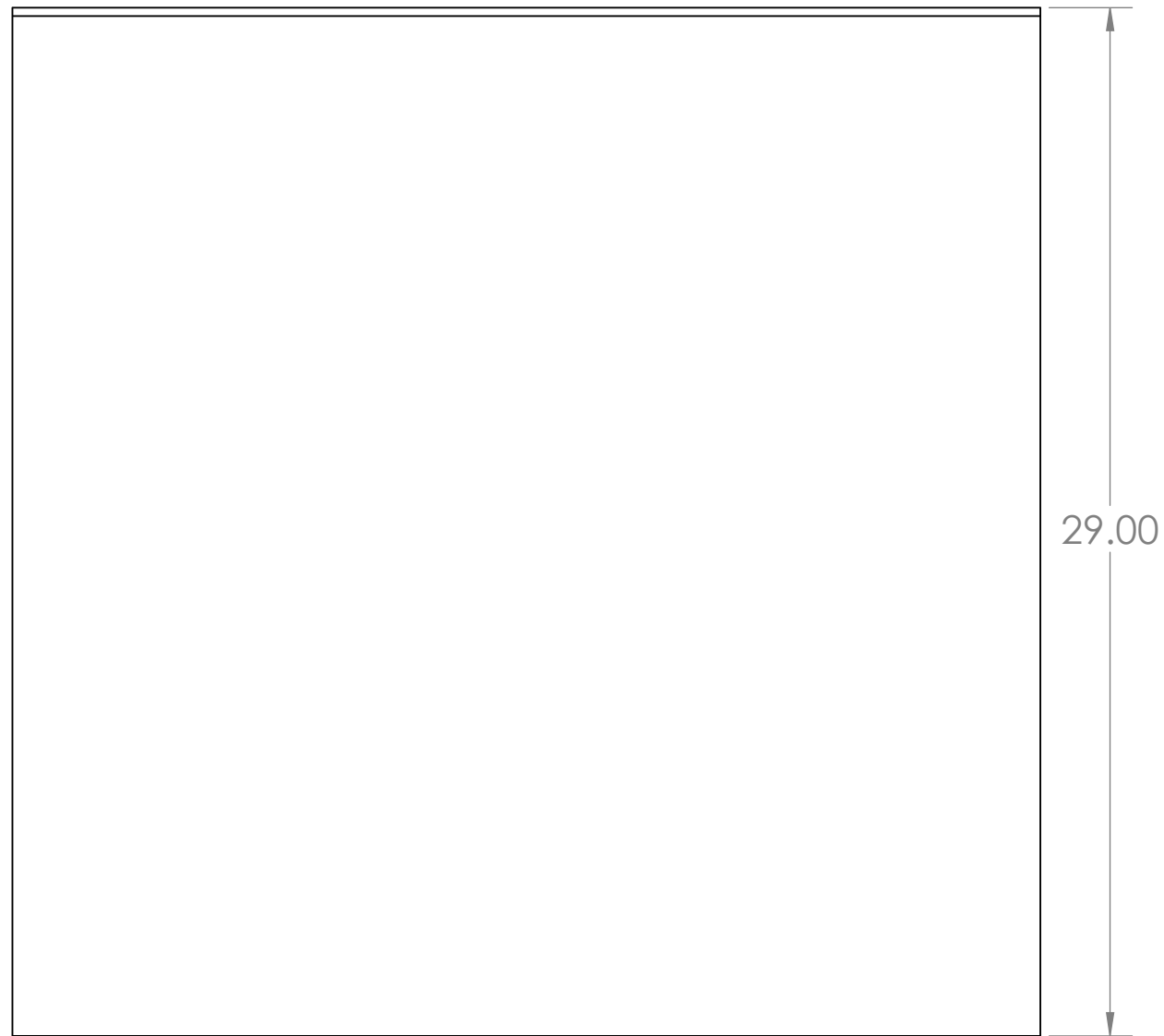

DETAIL A
SCALE 1 : 1

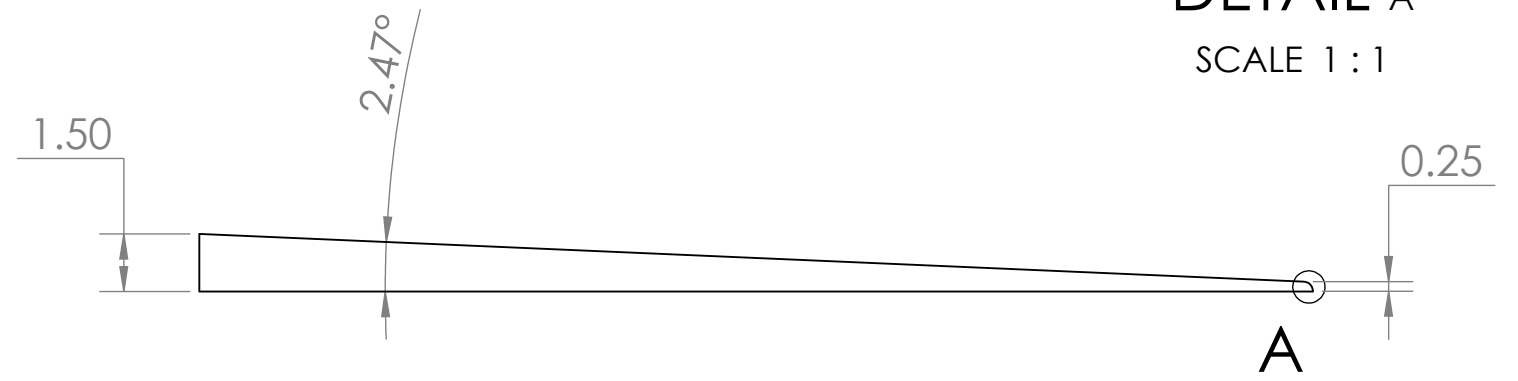

MEDAccess Inc.

Phone & Text **828-264-4085**

E-mail: medaccess@medaccessinc.com

Website: www.medaccessinc.com

RAMP
MODEL:

REDUCER 1300

RAMP
HEIGHT:

1.5 INCHES

LAST
UPDATE: 11/10/20

UNLESS OTHERWISE SPECIFIED:
DIMENSIONS ARE IN **INCHES**

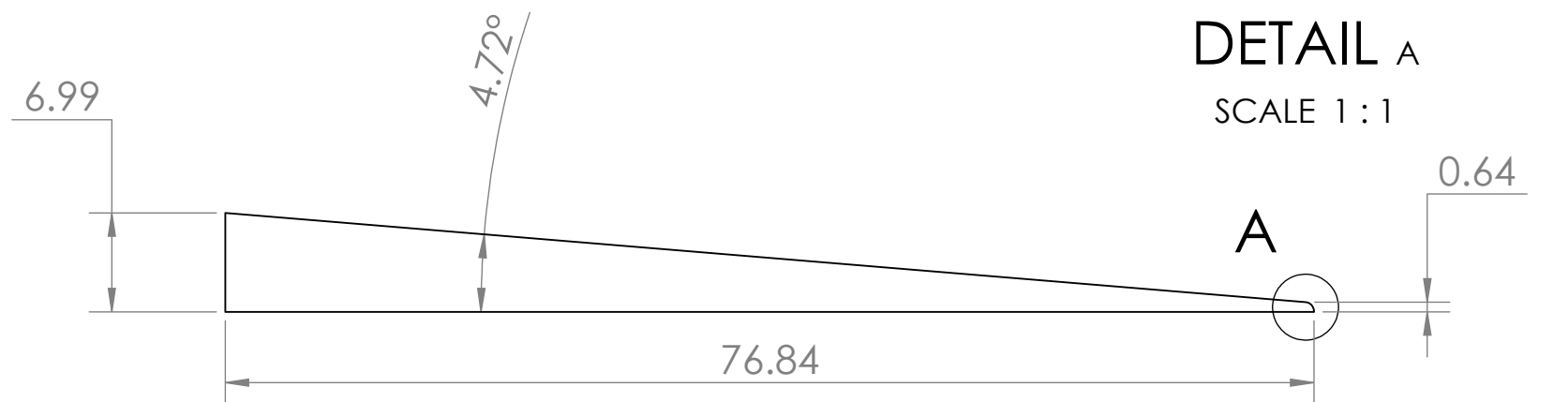
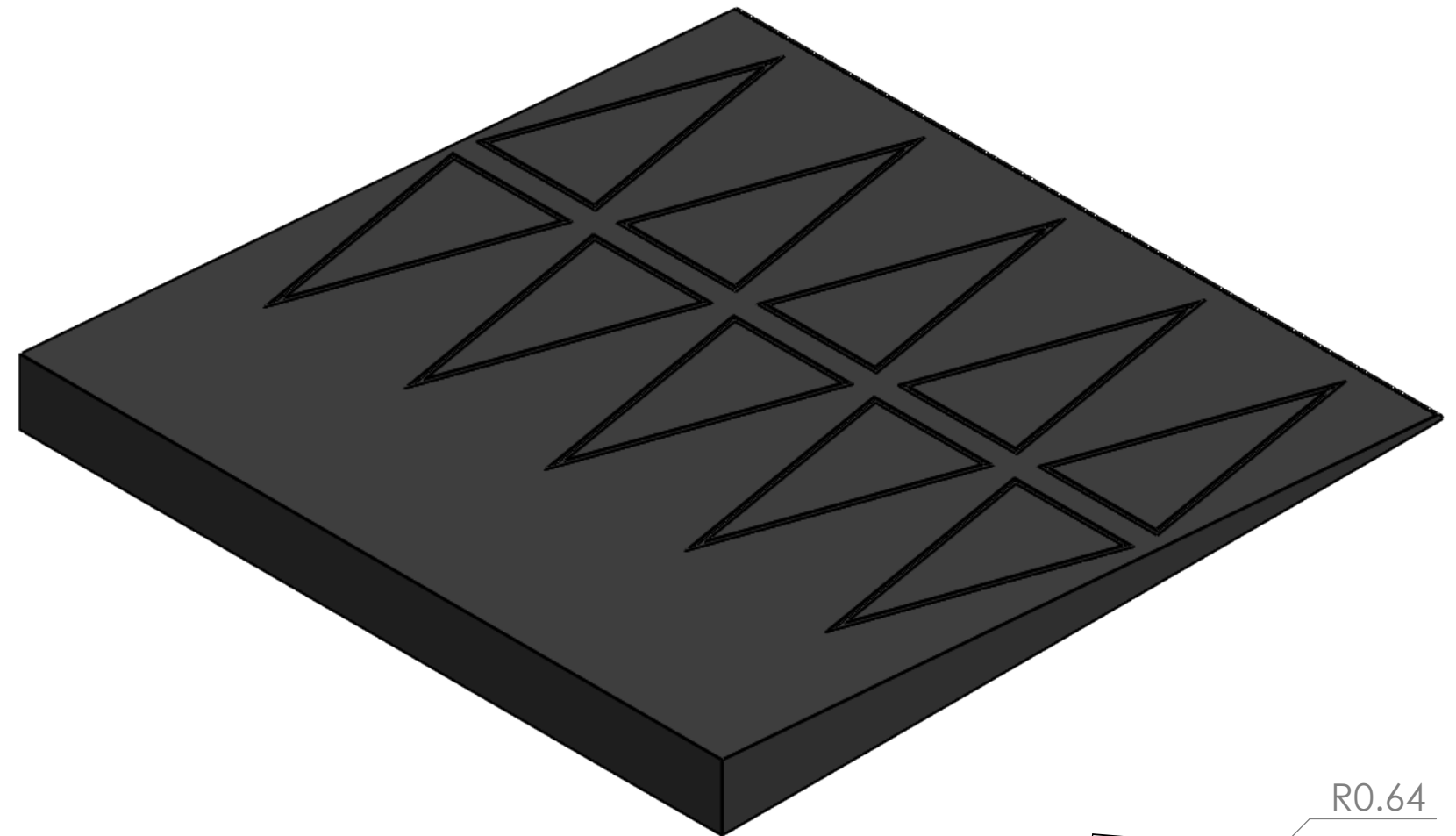
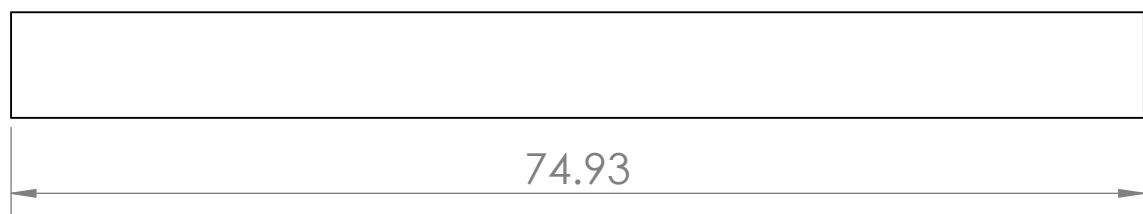
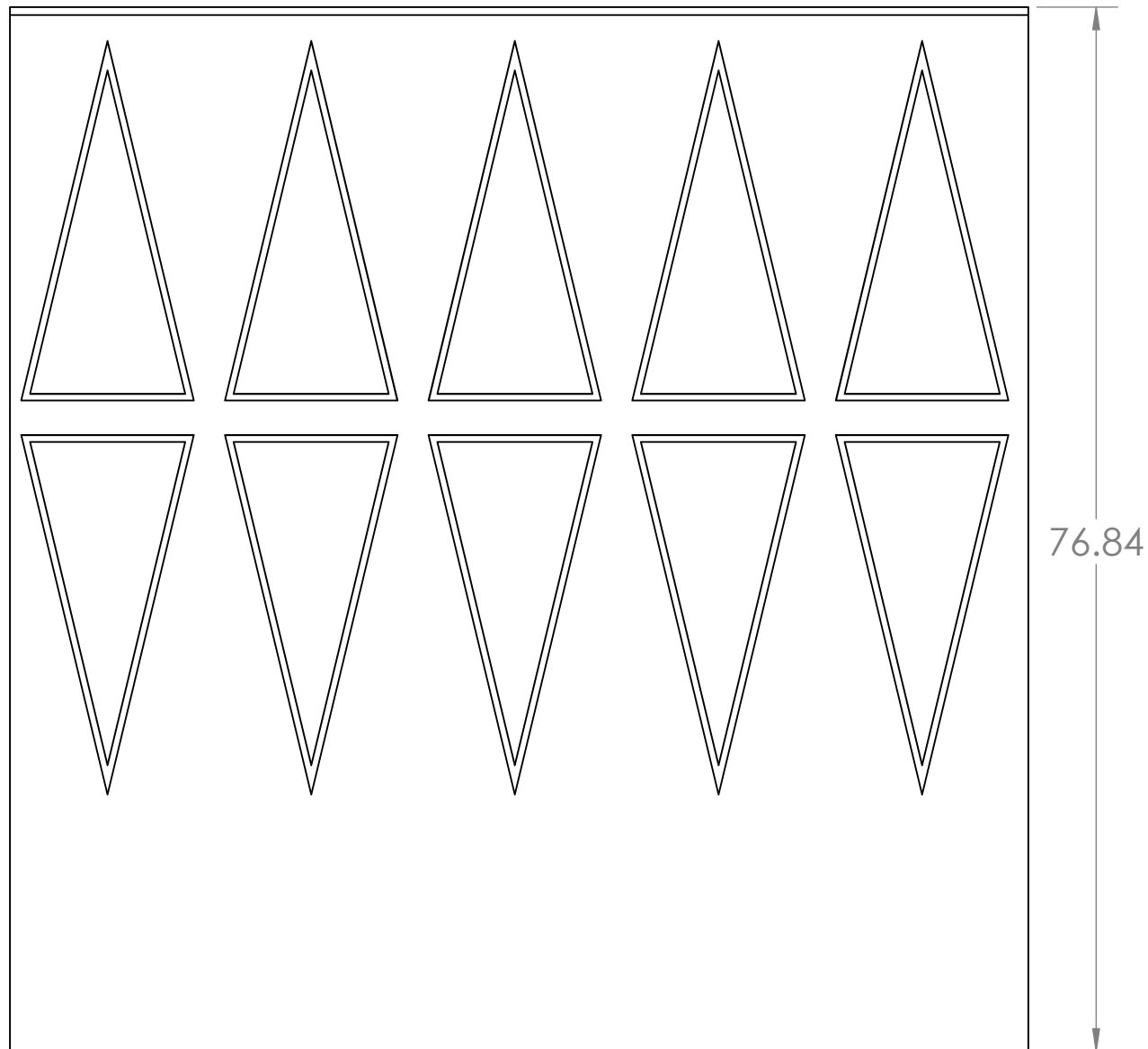

MEDAccess Inc.

Phone & Text **828-264-4085**

E-mail: medaccess@medaccessinc.com

Website: www.medaccessinc.com

RAMP
MODEL:

REDUCER 1400

RAMP
HEIGHT:

6.99 CM

LAST
UPDATE: 11/10/20

UNLESS OTHERWISE SPECIFIED:
DIMENSIONS ARE IN CENTIMETERS

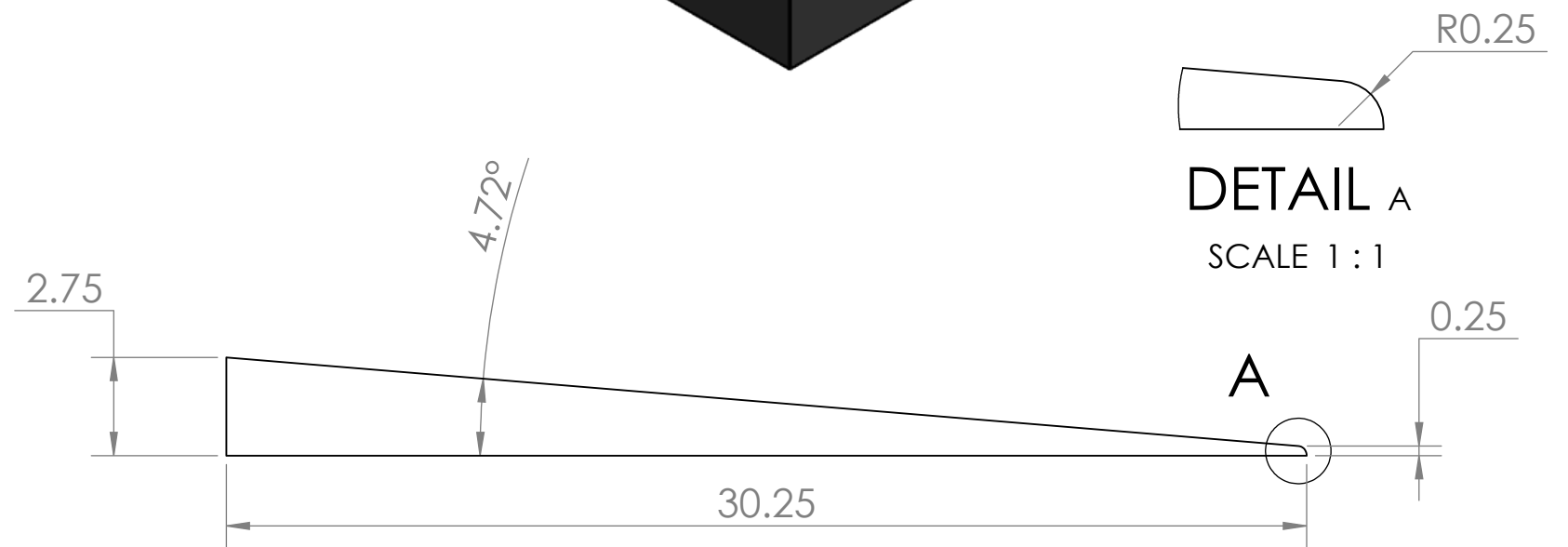
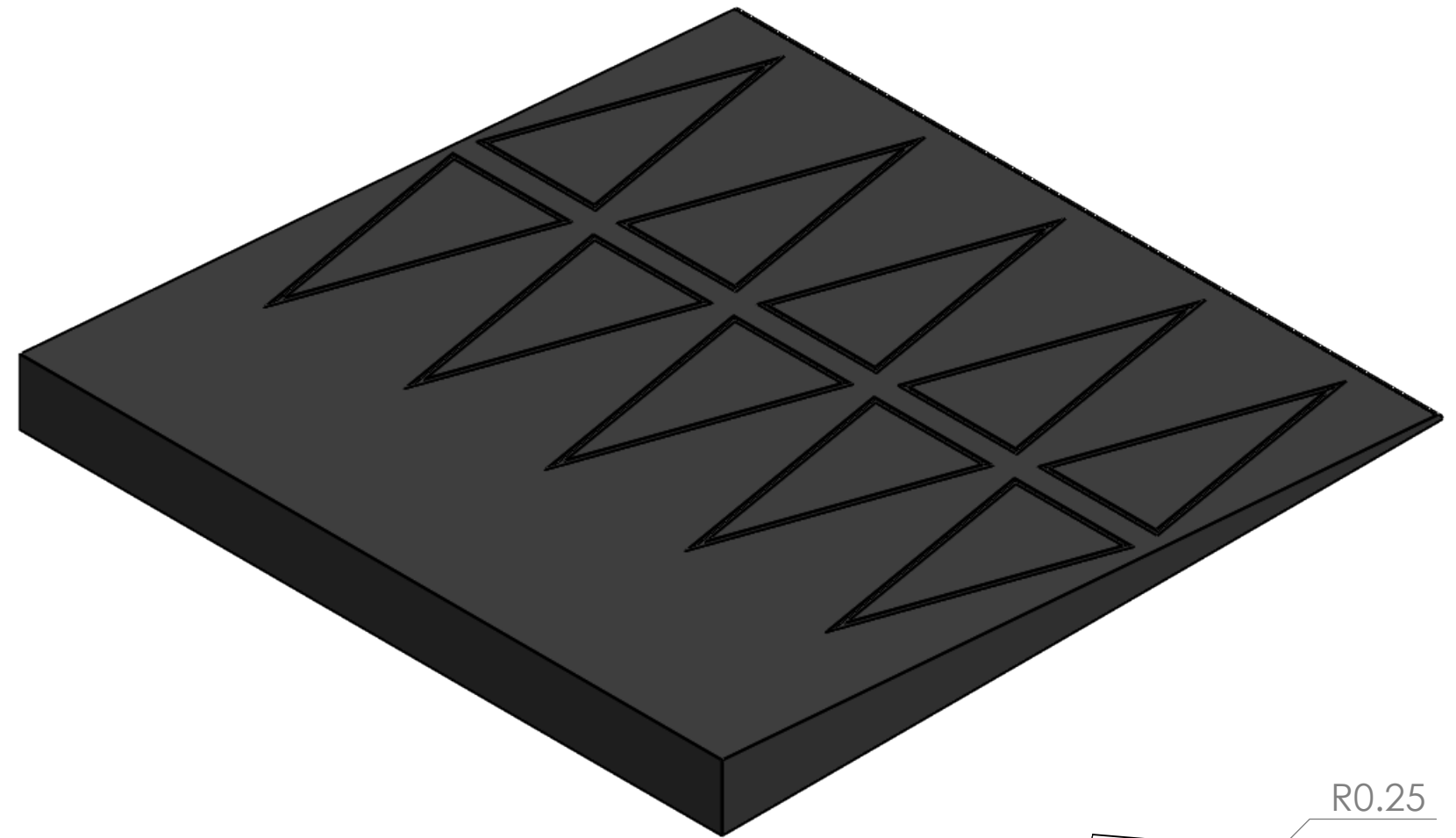
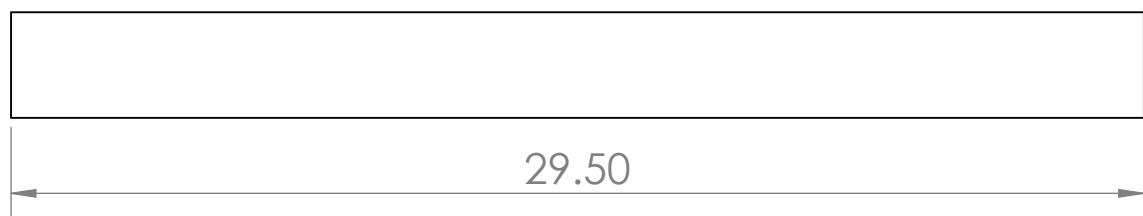
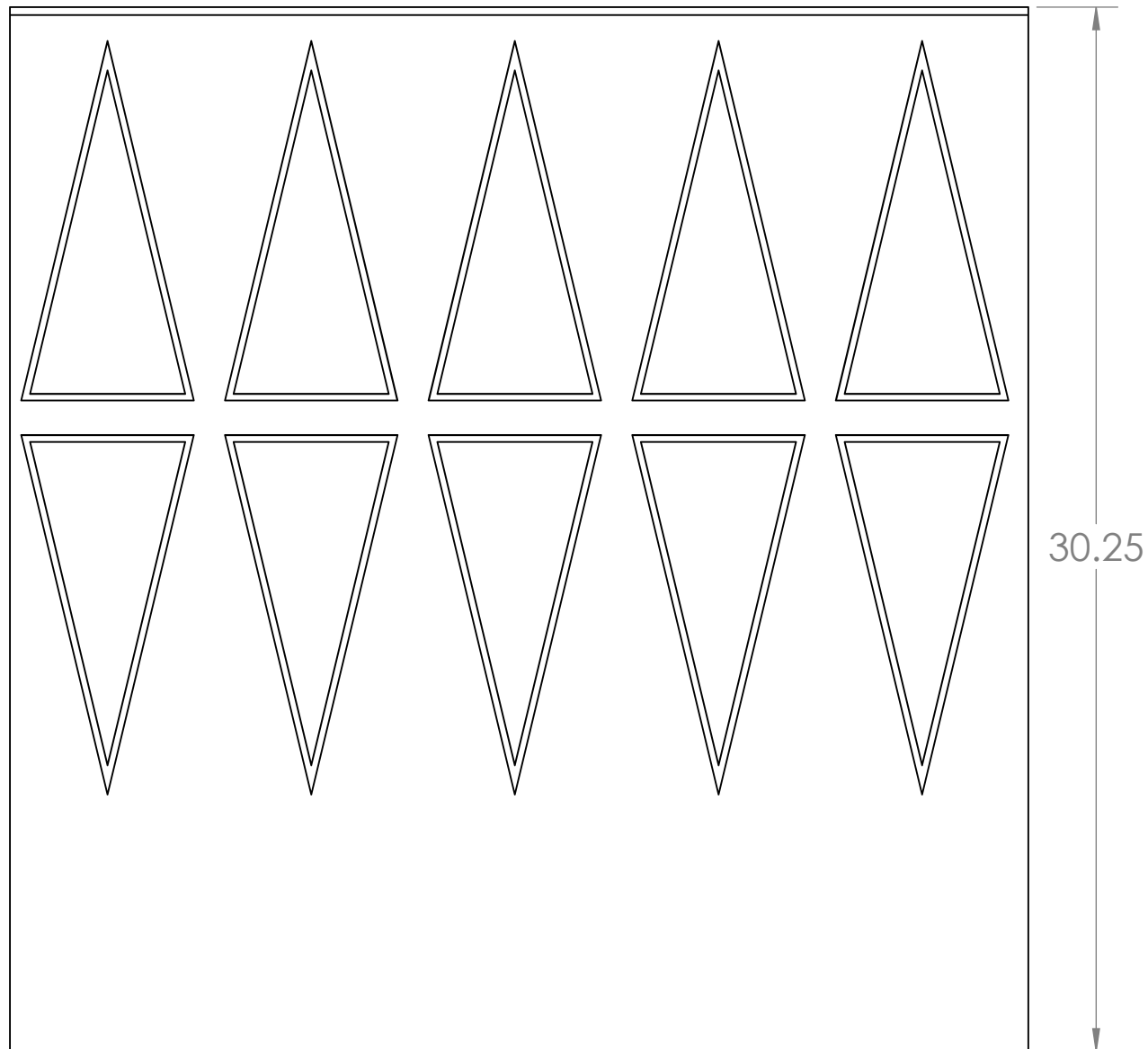

MEDAccess Inc.

Phone & Text **828-264-4085**

E-mail: medaccess@medaccessinc.com

Website: www.medaccessinc.com

RAMP
MODEL:

REDUCER 1400

RAMP
HEIGHT:

2.75 INCHES

LAST
UPDATE: 11/10/20

UNLESS OTHERWISE SPECIFIED:
DIMENSIONS ARE IN **INCHES**

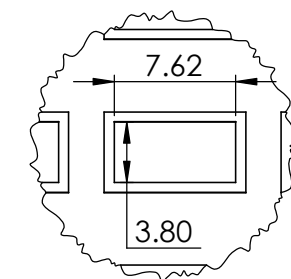
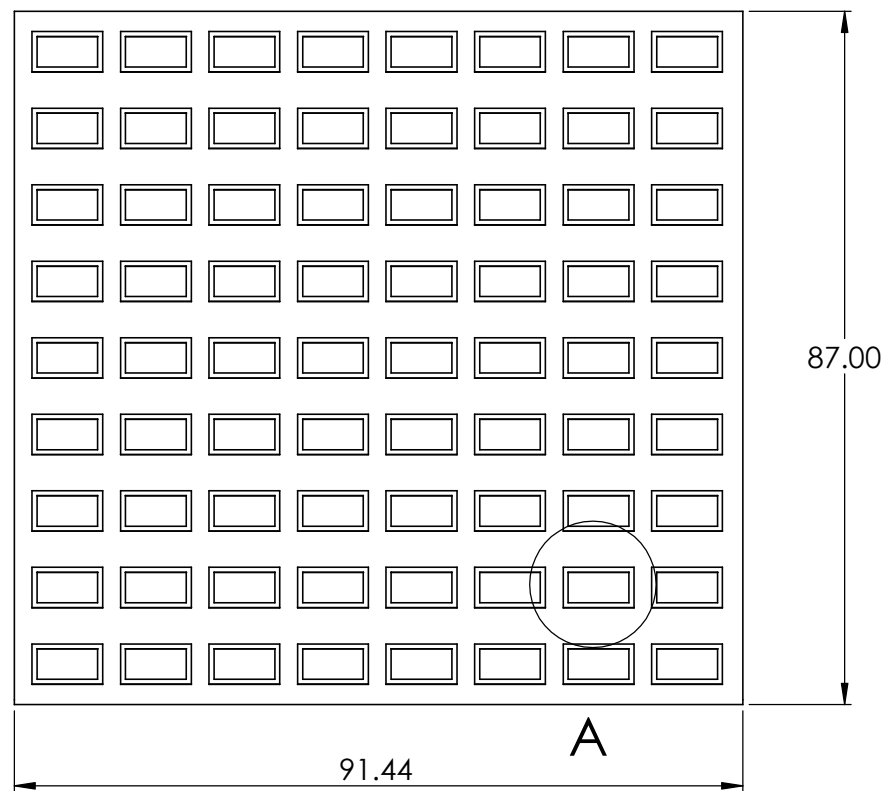

DETAIL A
SCALE 1 : 4

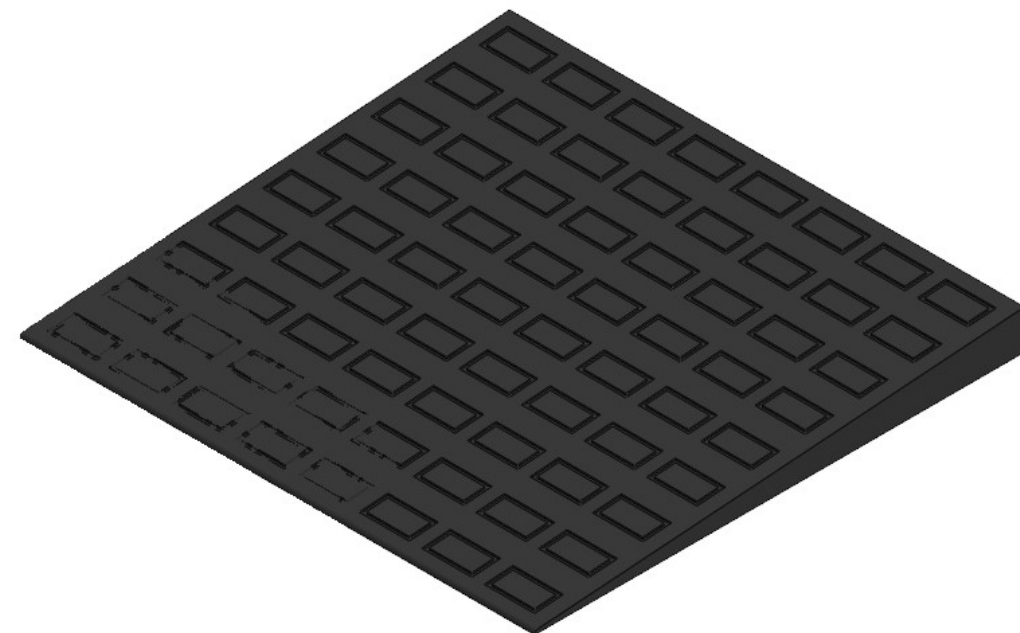

DETAIL B
SCALE 1 : 1

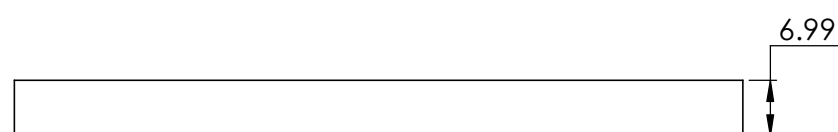

MEDAccess Inc.

Phone & Text **828-264-4085**

E-mail: medaccess@medaccessinc.com

Website: www.medaccessinc.com

RAMP
MODEL:

MRED 2190

RAMP
HEIGHT:

6.99 CM

LAST
UPDATE: 11/10/20

UNLESS OTHERWISE SPECIFIED:
DIMENSIONS ARE IN **CENTIMETERS**

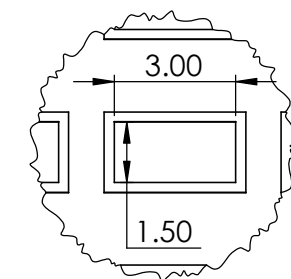
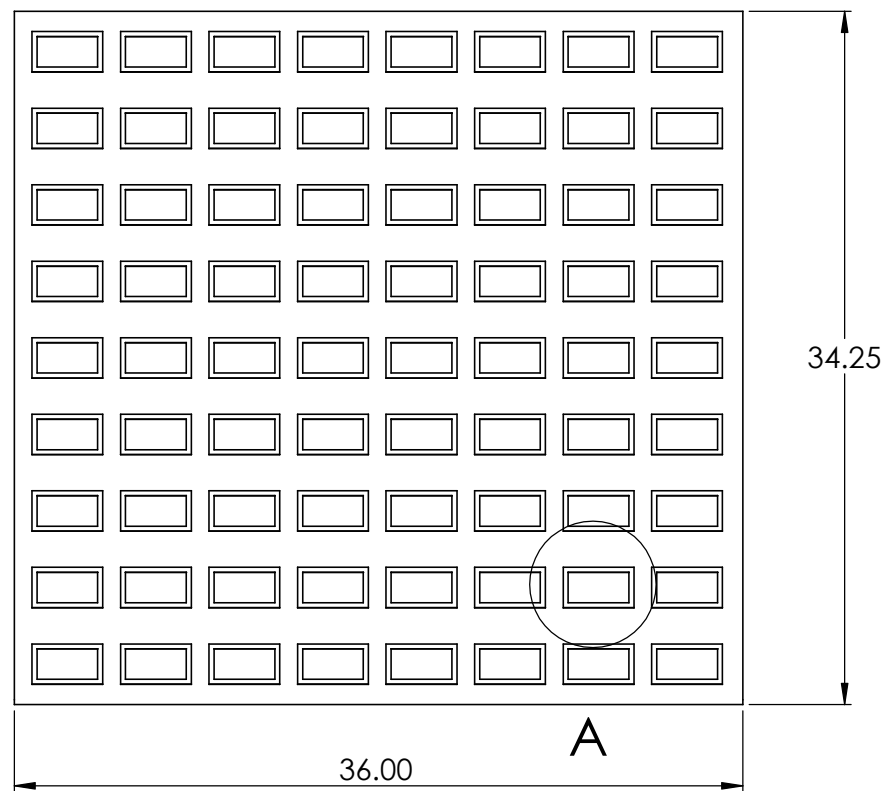

DETAIL A
SCALE 1 : 4

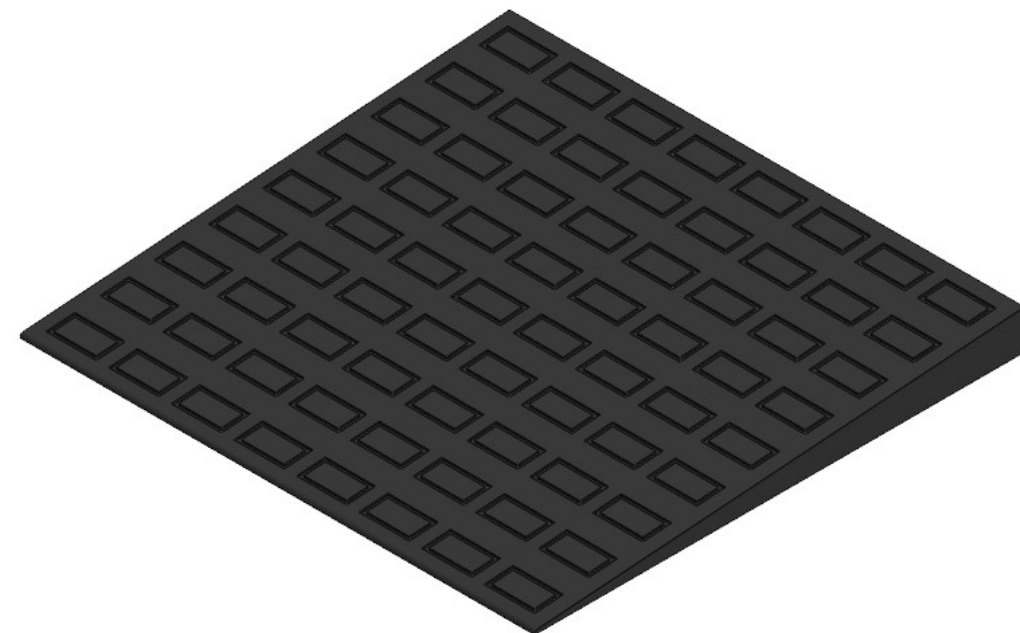

DETAIL B
SCALE 1 : 1

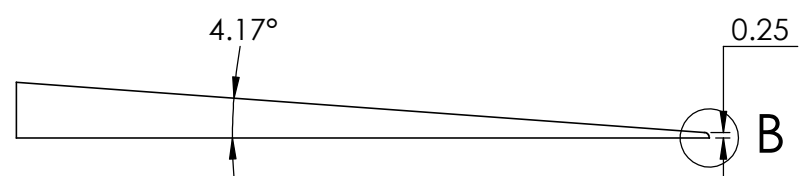

MEDAccess Inc.

Phone & Text **828-264-4085**

E-mail: medaccess@medaccessinc.com

Website: www.medaccessinc.com

RAMP MODEL:	MRED 2190
RAMP HEIGHT:	2.75 INCH
LAST UPDATE:	11/10/20
UNLESS OTHERWISE SPECIFIED: DIMENSIONS ARE IN INCHES	